

MEDICAL DEVICES

Volumat Lines

ADMINISTRATION SETS CATALOGUE
FOR VOLUMAT AGILIA RANGE

Agilia
Intuitive Generation

**DEHP
FREE**



**FRESENIUS
KABI**

caring for life

Administration sets for Volumat Agilia Range

NEW





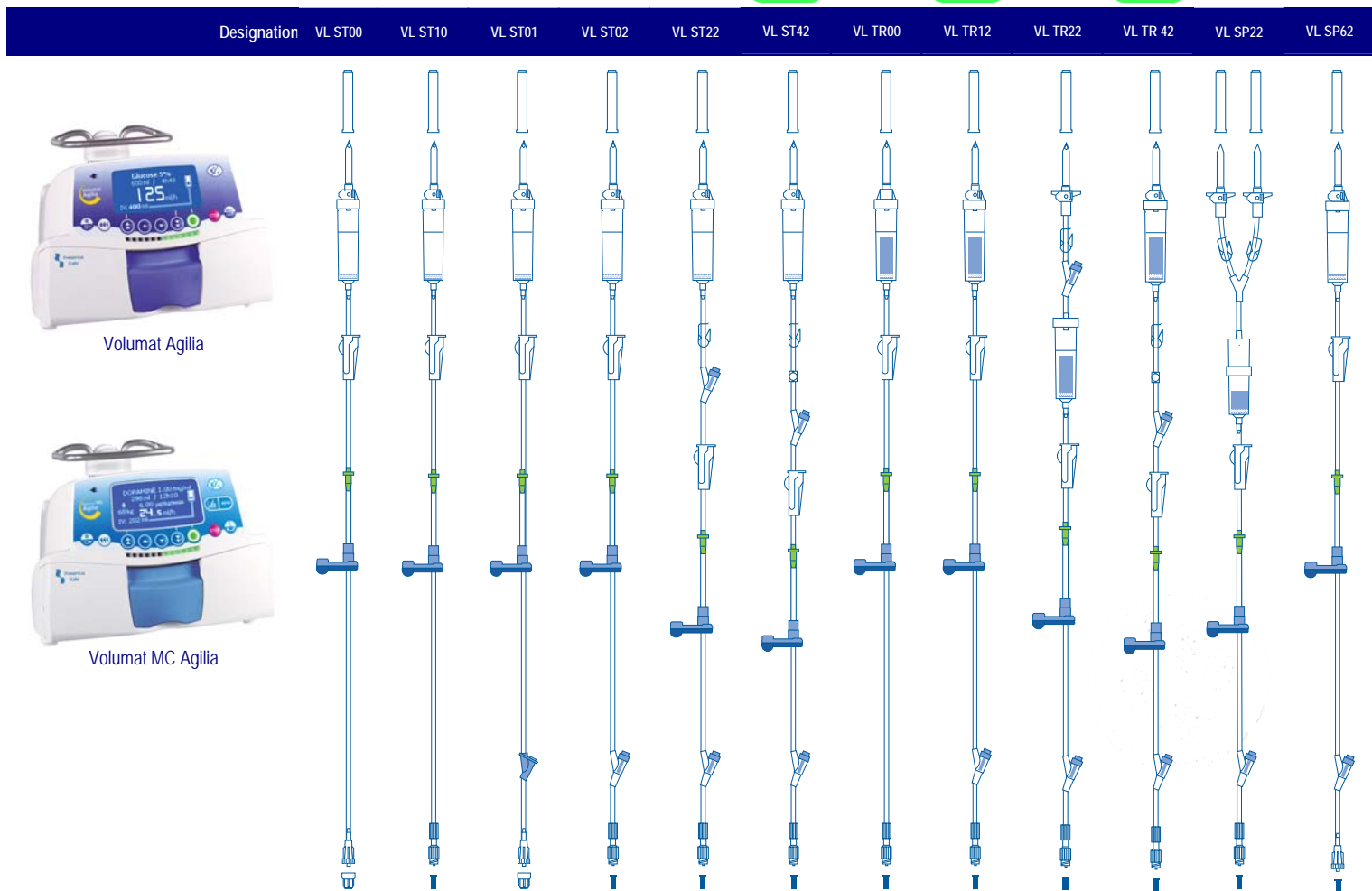





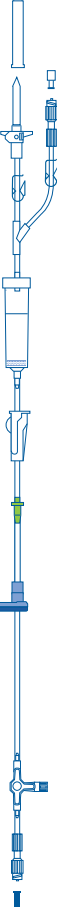

NEW

NEW



	Designation	VL ST00	VL ST10	VL ST01	VL ST02	VL ST22	VL ST42	VL TR00	VL TR12	VL TR22	VL TR 42	VL SP22	VL SP62
	APPLICATION	Infusion	Infusion	Infusion	Infusion	Infusion	Infusion	Transfusion	Transfusion	Transfusion	Transfusion	Transfusion	Infusion
	Vented spike & cap	■	■	■	■	■	■		■	■	■	■	■
	Non-vented spike & cap							■					
	Upstream drip chamber	■	■	■	■	■	■	■					■
	Inline drip chamber									■		■	
	Filter	15µ	15µ	15µ	15µ	15µ	15µ	200µ	200µ	200µ	200µ	200µ	15µ
Anti-bacterial and air eliminating filter													
	One-way check valve							■				■	
	Roller clamp	■	■	■	■	■	■	■	■	■	■	■	■
	Upstream robson clamp					■	■					■	■
	Upstream tubing Ø3x4.1mm (DEHP-free PVC)	~90cm	~90cm	~90cm	~90cm	~20+70cm	~35+60cm	~90cm	~90cm	~20+70cm	~30+60cm	~(2x15)+5+70cm	
	Other upstream tubing												~90cm PUR
	Calibrated silicone pumping segment	■	■	■	■	■	■	■	■	■	■	■	■
	Blue SafeClip: anti-free flow safety clamp	■	■	■	■	■	■	■	■	■	■	■	■
	Downstream tubing Ø3x4.1mm (DEHP-free PVC)	~165cm	~165cm	~145+20cm	~145+20cm	~145+20cm	~145+20cm	~165cm	~145+20cm	~145+20 cm	~145+20 cm	~145+20cm	
	Other downstream tubing												~145+20cm PP/PUR
	Injection site (latex-free)			■									
	Needle-free access				■	■	■		■	■	■	■	■
	150 ml burette												
	Male luer lock	■	■(rotating)	■	■(rotating)	■(rotating)	■(rotating)	■(rotating)	■(rotating)	■(rotating)	■(rotating)	■(rotating)	■
	Protector cap	std	stopflow	std	stopflow	stopflow	stopflow	stopflow	stopflow	stopflow	stopflow	stopflow	stopflow
	Main material	PVC	PVC	PVC	PVC	PVC	PVC	PVC	PVC	PVC	PVC	PVC	PVC-free
	Approximate length	~270cm	~270cm	~270cm	~270cm	~270cm	~275cm	~270cm	~270cm	~270cm	~275cm	~270cm	~270cm
	Priming volume	~25ml	~25ml	~25ml	~25ml	~25ml	~22ml	~25ml	~25ml	~25ml	~25ml	~30ml	~25ml
	Case quantity	70	30	30	30	30	30	30	30	30	30	30	30
	Article reference	M46441000	M46441300	M46441600	M46441900	M46442500	M46442600	M46442800	M46442700	M46443000	M46442900	M46443100	M46443400

Due to our policy of continuous product improvements as well as changes in standards, the features described in this documents may change. Please consult us for the current situation.

NEW		NEW		NEW		NEW		NEW		NEW				
VL SP90	VL SP92	VL PN00	VL PN02	VL PN20	VL ON10	VL ON20	VL ON30	VL ON42	VL ON70	VL ON72	VL ON90	VL PA02	VL PA92	
														
Infusion	Infusion	Infusion	Infusion	Infusion	Infusion	Infusion	Infusion	Infusion	Infusion	Infusion	Infusion	Infusion	Infusion	
■	■	■	■	■	■	■	■	■	■	■	■	■	■	
		■	■									■60dr	■	
15μ	15μ	15μ	15μ	15μ	15μ	15μ	15μ	15μ	15μ	15μ	15μ	15μ	15μ	
		1.2μ	1.2μ						0.2μ positively charged	0.2μ positively charged				
■	■	■	■	■	■	■	■	■	■	■	■	■	■	
■	■	■	■	■	■	■	■	■	■	■	■	■	■	
~90cm PUR	~90cm PUR	~90cm	~90cm	~15+70cm	30+50cm	35+50cm	40+50cm		~45+70cm PUR	~90cm PUR	~90cm PUR	~90cm opaque PUR	~50cm	
■	■	■	■	■	■	■	■	■	■	■	■	■	■	
■	■	■	■	■	■	■	■	■	■	■	■	■	■	
~160cm PUR	~145+20cm PUR	~145+20cm	~150+20cm	~165cm	~165+30cm	~165+30cm	~165+30cm						~165cm	
									~165cm PP	~145+20cm PP	~145 +20cm PP	~165cm opaque PUR	~70+20cm int Ø2.0 PVC	
									■	■	■	■	■	
■	■	■	■	■	■	■	■	■	■	■	■	■	■	
■	■(rotating)	■(rotating)	■(rotating)	■(rotating)	■(rotating)	■(rotating)	■(rotating)	■(rotating)	■	■	■	■	■(rotating)	
stopflow	stopflow	stopflow	stopflow	stopflow	stopflow	stopflow	stopflow	stopflow	stopflow	stopflow	stopflow	stopflow	stopflow	
PVC-free	PVC-free	PVC	PVC	PVC	PVC	PVC	PVC	PVC	PVC-free	PVC-free	PVC-free	PVC-free	PVC	
~270cm	~270cm	~270cm	~275cm	~270cm	~270-280cm	~270-280cm	~270-280cm	~270cm	~270cm	~275cm	~270cm	~160cm	~300cm	
~25ml	~25ml	~25ml	~25ml	~26ml	~28ml	~30ml	~33ml	~30ml	~25ml	~25ml	~25ml	~15ml	~25ml	
30	30	30	30	30	30	30	30	30	30	30	30	30	10	
M46443500	M46443600	M46444300	M46444400	M464443700	M464445500	M464445700	M464445900	M46444000	M46444600	M46444100	M46444900	M46442200	M46445200	

Due to our policy of continuous product improvements as well as changes in standards, the features described in this documents may change. Please consult us for the current situation.

VL ST00

M46441000

Standard set for infusion, 15 μ filter

To infuse fluid bags or bottles with Volumat Agilia / Volumat MC Agilia infusion pumps.

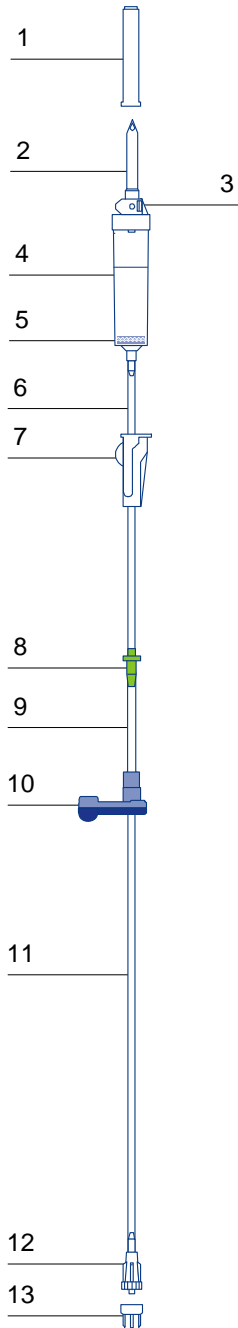

Description

- | | Description |
|-----|--|
| 1. | Protector cap |
| 2. | Vented spike |
| 3. | Air inlet with antibacterial filter and cap |
| 4. | Transparent drip chamber, length ~ 65 mm |
| 5. | 15 μ filter |
| 6. | PVC tubing (DEHP-free): diameter 3 x 4.1 mm, length ~ 90 cm |
| 7. | Roller clamp |
| 8. | Green connector |
| 9. | Calibrated silicone pumping segment |
| 10. | Blue SafeClip: anti-free flow safety clamp |
| 11. | PVC tubing (DEHP-free): diameter 3 x 4.1 mm, length ~ 165 cm |
| 12. | Male Luer Lock |
| 13. | Protector cap |

Approximate length: ~ 270 cm

Approximate priming volume: ~ 25 ml

Main materials: PVC, Silicone

Important: DEHP-free, latex-free

Packaging

- Peel-open pouch.
- Ethylene oxide sterilization.
- Expiry: 5 years after manufacturing.
- Case quantity: 70 units (14x5).
- Pallet of 2240 sets.
- Storage conditions: +5 to +30°C, maximum humidity 70%.

Applications

- Infusion of drugs / fluids having no particular filtration requirements.
- Infusion of drugs / fluids having no particular incompatibility.

Not to be used for

- Infusion of drugs known to be incompatible with PVC (e.g. trinitrine, isosorbide dinitrate, sodium nitroprussiate...).
- Blood products.
- Light sensitive drugs (unless other precautions are taken to protect the drug against direct light).

Advantages

- No leach of DEHP.
- Security of good set positioning in the pump.
- Security against free flow when the set is removed from the pump.
- Set recognition by the pump.
- Preparation and priming similar to a gravity set.
- Possible use with any bags or bottles.
- Visual control of the infusion.
- Possible use by gravity.
- No risk of allergy to latex.

VL ST10

M46441300

Standard set for infusion, 15µ filter, rotating luer lock, stopflow cap

To infuse fluid bags or bottles with Volumat Agilia / Volumat MC Agilia infusion pumps.

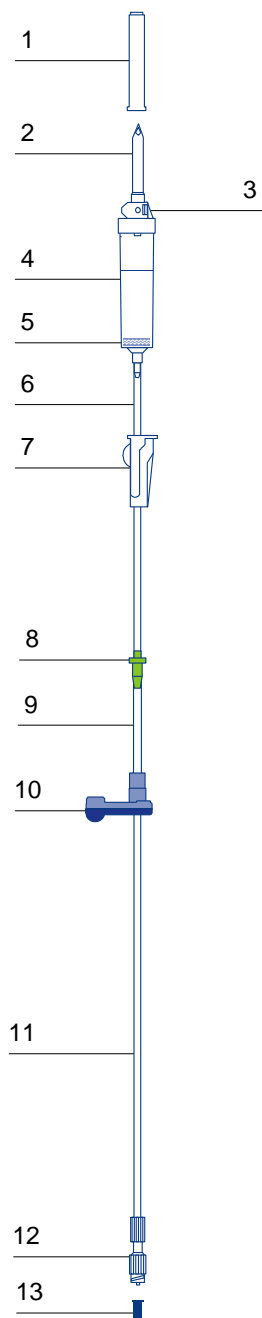

Description

- | | |
|-----|--|
| 1. | Protector cap |
| 2. | Vented spike |
| 3. | Air inlet with antibacterial filter and cap |
| 4. | Transparent drip chamber, length ~ 65 mm |
| 5. | 15 µ filter |
| 6. | PVC tubing (DEHP-free): diameter 3 x 4.1 mm, length ~ 90 cm |
| 7. | Roller clamp |
| 8. | Green connector |
| 9. | Calibrated silicone pumping segment |
| 10. | Blue SafeClip: anti-free flow safety clamp |
| 11. | PVC tubing (DEHP-free): diameter 3 x 4.1 mm, length ~ 165 cm |
| 12. | Rotating Male Luer Lock |
| 13. | Stopflow cap |

Approximate length: ~ 270 cm

Approximate priming volume: ~ 25 ml

Main materials: PVC, Silicone

Important: DEHP-free, latex-free

Packaging

- Peel-open pouch.
- Ethylene oxide sterilization.
- Expiry: 5 years after manufacturing.
- Case quantity: 30 units (6x5).
- Pallet of 1680 sets.
- Storage conditions: +5 to +30°C, maximum humidity 70%.

Applications

- Infusion of drugs / fluids having no particular filtration requirements.
- Infusion of drugs / fluids having no particular incompatibility.

Not to be used for

- Infusion of drugs known to be incompatible with PVC (e.g. trinitrine, isosorbide dinitrate, sodium nitroprussiate...).
- Blood products.
- Light sensitive drugs (unless other precautions are taken to protect the drug against direct light).

Advantages

- No leach of DEHP.
- Automatic prime stop thanks to a hydrophobic filter contained in the downstream protector cap.
- Security of good set positioning in the pump.
- Security against free flow when the set is removed from the pump.
- Set recognition by the pump.
- Preparation and priming similar to a gravity set.
- Possible use with any bags or bottles.
- Visual control of the infusion.
- Possible use by gravity.
- No risk of allergy to latex.

VL ST01

M46441600

Standard set for infusion, 15µ filter, injection site

To infuse fluid bags or bottles with Volumat Agilia / Volumat MC Agilia infusion pumps.

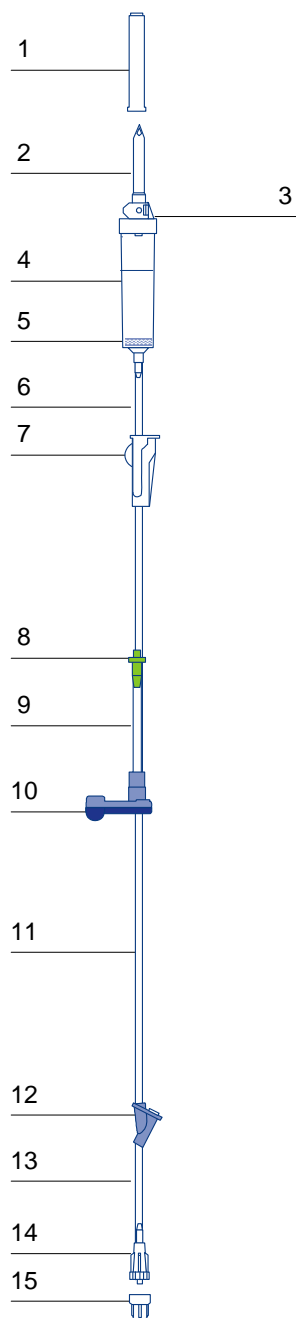

Description

1.	Protector cap
2.	Vented spike
3.	Air inlet with antibacterial filter and cap
4.	Transparent drip chamber, length ~ 65 mm
5.	15 µ filter
6.	PVC tubing (DEHP-free): diameter 3 x 4.1 mm, length ~ 90 cm
7.	Roller clamp
8.	Green connector
9.	Calibrated silicone pumping segment
10.	Blue SafeClip: anti-free flow safety clamp
11.	PVC tubing (DEHP-free): diameter 3 x 4.1 mm, length ~ 145 cm
12.	Injection site in « Y », latex-free
13.	PVC tubing (DEHP-free): diameter 3 x 4.1 mm, length ~ 20 cm
14.	Male Luer Lock
15.	Protector cap

Approximate length: ~ 270 cm

Approximate priming volume: ~ 25 ml

Main materials: PVC, Silicone

Important: DEHP-free, latex-free

Packaging

- Peel-open pouch.
- Ethylene oxide sterilization.
- Expiry: 5 years after manufacturing.
- Case quantity: 30 units (6x5).
- Pallet of 1680 sets.
- Storage conditions: +5 to +30°C, maximum humidity 70%.

Applications

- Infusion of drugs / fluids having no particular filtration requirements.
- Infusion of drugs / fluids having no particular incompatibility.

Not to be used for

- Infusion of drugs known to be incompatible with PVC (e.g. trinitrine, isosorbide dinitrate, sodium nitroprussiate...).
- Blood products.
- Light sensitive drugs (unless other precautions are taken to protect the drug against direct light).

Advantages

- No leach of DEHP.
- Allows intermittent injections of drugs.
- Security of good set positioning in the pump.
- Security against free flow when the set is removed from the pump.
- Set recognition by the pump.
- Preparation and priming similar to a gravity set.
- Possible use with any bags or bottles.
- Visual control of the infusion.
- Possible use by gravity.
- No risk of allergy to latex.

VL ST02

M46441900

Standard set for infusion, 15µ filter, K-Nect needle-free access

To infuse fluid bags or bottles with Volumat Agilia / Volumat MC Agilia infusion pumps.

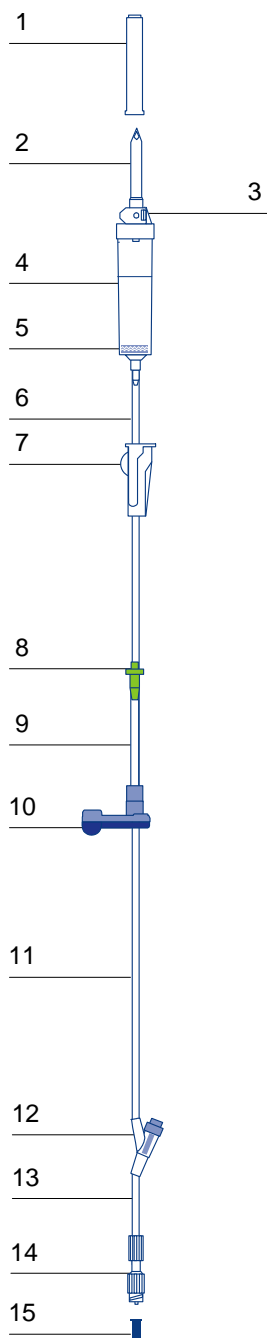

Description

1.	Protector cap
2.	Vented spike
3.	Air inlet with antibacterial filter and cap
4.	Transparent drip chamber, length ~ 65 mm
5.	15 µ filter
6.	PVC tubing (DEHP-free): diameter 3 x 4.1 mm, length ~ 90 cm
7.	Roller clamp
8.	Green connector
9.	Calibrated silicone pumping segment
10.	Blue SafeClip: anti-free flow safety clamp
11.	PVC tubing (DEHP-free): diameter 3 x 4.1 mm, length ~ 145 cm
12.	K-Nect Needle-free access
13.	PVC tubing (DEHP-free): diameter 3 x 4.1 mm, length ~ 20 cm
14.	Rotating Male Luer Lock
15.	Stopflow cap

Approximate length: ~ 270 cm

Approximate priming volume: ~ 25 ml

Main materials: PVC, Silicone

Important: DEHP-free, latex-free

Packaging

- Peel-open pouch.
- Ethylene oxide sterilization.
- Expiry: 5 years after manufacturing.
- Case quantity: 30 units (6x5).
- Pallet of 1680 sets.
- Storage conditions: +5 to +30°C, maximum humidity 70%.

Applications

- Infusion of drugs / fluids having no particular filtration requirements.
- Infusion of drugs / fluids having no particular incompatibility.

Not to be used for

- Infusion of drugs known to be incompatible with PVC (e.g. trinitrine, isosorbide dinitrate, sodium nitroprussiate...).
- Blood products.
- Light sensitive drugs (unless other precautions are taken to protect the drug against direct light).
- Needle-free access should not be used to connect a gravity line (unless it is protected by a back check valve).

Advantages

- No leach of DEHP.
- Automatic prime stop thanks to a hydrophobic filter contained in the downstream protector cap.
- Allows intermittent injections of drugs.
- Reduces risk of needle-stick injuries.
- Security of good set positioning in the pump.
- Security against free flow when the set is removed from the pump.
- Set recognition by the pump.
- Preparation and priming similar to a gravity set.
- Possible use with any bags or bottles.
- Visual control of the infusion.
- Possible use by gravity.
- No risk of allergy to latex.

VL ST22 NEW

M46442500

Standard set for infusion, 15µ filter, with 2 K-Nect needle-free accesses

To infuse fluid bags or bottles with Volumat Agilia / Volumat MC Agilia infusion pumps.

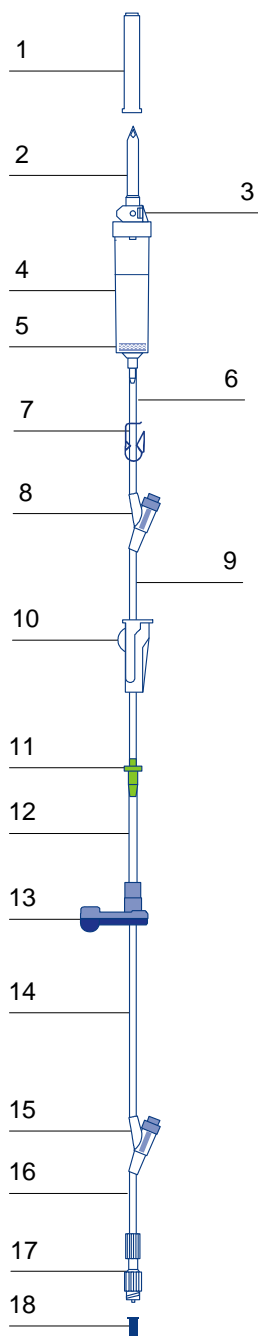

Description	
1.	Protector cap
2.	Vented spike
3.	Air inlet with antibacterial filter and cap
4.	Transparent drip chamber, length ~ 65 mm
5.	15 µ filter
6.	PVC tubing (DEHP-free): diameter 3 x 4.1 mm, length ~ 20 cm
7.	Robson clamp
8.	K-Nect Needle-free access
9.	PVC tubing (DEHP-free): diameter 3 x 4.1 mm, length ~ 70 cm
10.	Roller clamp
11.	Green connector
12.	Calibrated silicone pumping segment
13.	Blue SafeClip: anti-free flow safety clamp
14.	PVC tubing (DEHP-free): diameter 3 x 4.1 mm, length ~ 145 cm
15.	K-Nect Needle-free access
16.	PVC tubing (DEHP-free): diameter 3 x 4.1 mm, length ~ 20 cm
17.	Rotating Male Luer Lock
18.	Stopflow cap

Approximate length: ~ 270 cm

Approximate priming volume: ~ 25 ml

Main materials: PVC, Silicone

Important: DEHP-free, latex-free

Packaging	
■	Peel-open pouch.
■	Ethylene oxide sterilization.
■	Expiry: 5 years after manufacturing.
■	Case quantity: 30 units (6x5).
■	Pallet of 1680 sets.
■	Storage conditions: +5 to +30°C, maximum humidity 70%.

Applications	
■	Infusion of drugs / fluids having no particular filtration requirements.
■	Infusion of drugs / fluids having no particular incompatibility.

Not to be used for	
■	Infusion of drugs known to be incompatible with PVC (e.g. trinitrine, isosorbide dinitrate, sodium nitroprussiate...).
■	Blood products.
■	Light sensitive drugs (unless other precautions are taken to protect the drug against direct light).
■	Needle-free access should not be used to connect a gravity line (unless it is protected by a back check valve).

Advantages	
■	No leach of DEHP.
■	Automatic prime stop thanks to a hydrophobic filter contained in the downstream protector cap.
■	Allows connection of secondary lines for piggy-backing.
■	Allows intermittent injections of drugs.
■	Reduces risk of needle-stick injuries.
■	Security of good set positioning in the pump.
■	Security against free flow when the set is removed from the pump.
■	Set recognition by the pump.
■	Preparation and priming similar to a gravity set.
■	Possible use with any bags or bottles.
■	Visual control of the infusion.
■	Possible use by gravity.
■	No risk of allergy to latex.

VL ST42 NEW

M46442600

Standard set for infusion, 15 μ filter, 2 K-Nect needle-free accesses, 1 one-way check valve

To infuse fluid bags or bottles with Volumat Agilia / Volumat MC Agilia infusion pumps.

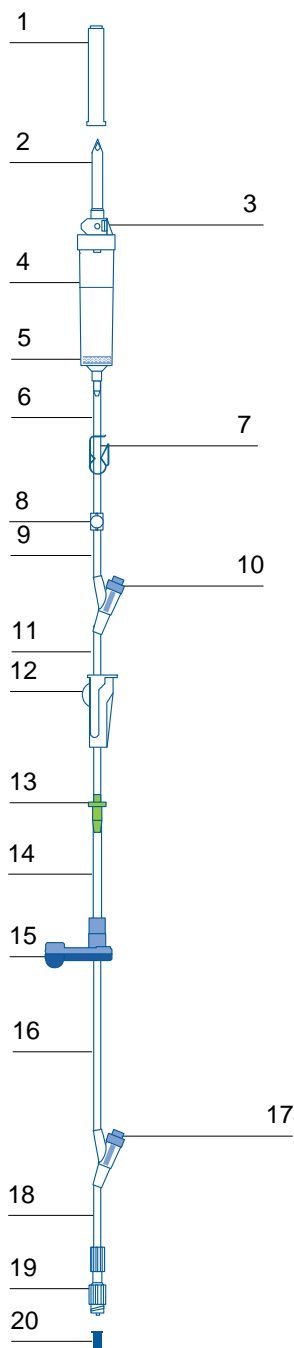

	Description
1.	Protector cap
2.	Vented spike
3.	Air inlet with antibacterial filter and cap
4.	Transparent drip chamber, length ~ 65 mm
5.	15 μ filter
6.	PVC tubing (DEHP-free): diameter 3 x 4.1 mm, length ~ 30 cm
7.	Robson clamp
8.	One-way check valve
9.	PVC tubing (DEHP-free): diameter 3 x 4.1 mm, length ~ 5 cm
10.	K-Nect Needle-free access
11.	PVC tubing (DEHP-free): diameter 3 x 4.1 mm, length ~ 60 cm
12.	Roller clamp
13.	Green connector
14.	Calibrated silicone pumping segment
15.	Blue SafeClip: anti-free flow safety clamp
16.	PVC tubing (DEHP-free): diameter 3 x 4.1 mm, length ~ 145 cm
17.	K-Nect Needle-free access
18.	PVC tubing (DEHP-free): diameter 3 x 4.1 mm, length ~ 20 cm
19.	Rotating Male Luer Lock
20.	Stopflow cap

Approximate length: ~ 275 cm

Approximate priming volume: ~ 22 ml

Main materials: PVC, Silicone

Important: DEHP-free, latex-free

Packaging
<ul style="list-style-type: none"> ■ Peel-open pouch. ■ Ethylene oxide sterilization. ■ Expiry: 5 years after manufacturing. ■ Case quantity: 30 units (6x5). ■ Pallet of 1680 sets. ■ Storage conditions: +5 to +30°C, maximum humidity 70%.

Applications
<ul style="list-style-type: none"> ■ Infusion of drugs / fluids having no particular filtration requirements. ■ Infusion of drugs / fluids having no particular incompatibility.

Not to be used for
<ul style="list-style-type: none"> ■ Infusion of drugs known to be incompatible with PVC (e.g. trinitrine, isosorbide dinitrate, sodium nitroprussiate...). ■ Blood products. ■ Light sensitive drugs (unless other precautions are taken to protect the drug against direct light). ■ Needle-free access should not be used to connect a gravity line (unless it is protected by a back check valve).

Advantages
<ul style="list-style-type: none"> ■ No leach of DEHP. ■ Automatic prime stop thanks to a hydrophobic filter contained in the downstream protector cap. ■ Allows intermittent injections of drugs. ■ Reduces risk of needle-stick injuries. ■ Security of good set positioning in the pump. ■ Security against free flow when the set is removed from the pump. ■ Set recognition by the pump. ■ Preparation and priming similar to a gravity set. ■ Possible use with any bags or bottles. ■ Visual control of the infusion. ■ Possible use by gravity. ■ No risk of allergy to latex.

VL TR00

M46442800

Set for transfusion, 200 µ filter

To infuse blood bags with Volumat Agilia / Volumat MC Agilia infusion pumps.

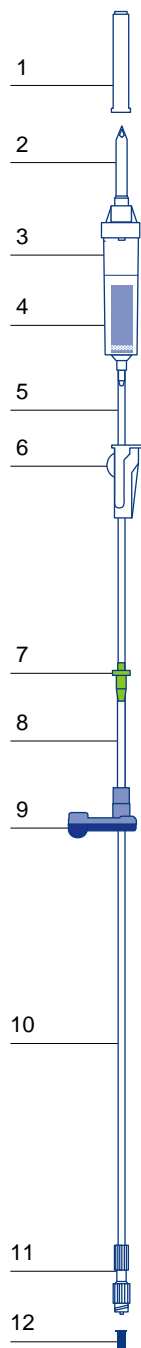

Description	
1.	Protector cap
2.	Non vented spike for blood bags, compliant with ISO 1135/4
3.	Transparent drip chamber, length ~ 90 mm
4.	Blood filter 200 µ (surface > 10 cm ²)
5.	PVC tubing (DEHP-free): diameter 3 x 4.1 mm, length ~ 90 cm
6.	Roller clamp
7.	Green connector
8.	Calibrated silicone pumping segment
9.	Blue SafeClip: anti-free flow safety clamp
10.	PVC tubing (DEHP-free): diameter 3 x 4.1 mm, length ~ 165 cm
11.	Rotating Male Luer Lock
12.	Stopflow cap

Approximate length: ~ 270 cm

Approximate priming volume: ~ 25 ml

Main materials: PVC, Silicone

Important: DEHP-free, latex-free

Packaging
<ul style="list-style-type: none"> ■ Peel-open pouch. ■ Ethylene oxide sterilization. ■ Expiry: 5 years after manufacturing. ■ Case quantity: 30 units (6x5). ■ Pallet of 1680 sets. ■ Storage conditions: +5 to +30°C, maximum humidity 70%.

Applications
<ul style="list-style-type: none"> ■ Transfusion of blood products available in bags.

Not to be used for
<ul style="list-style-type: none"> ■ Bottles. ■ Infusion of drugs / fluids requiring a filtration with a narrow diameter filter. ■ Infusion of drugs known to be incompatible with PVC (e.g. trinitrine, isosorbide dinitrate, sodium nitroprussiate...). ■ Light sensitive drugs (unless other precautions are taken to protect the drug against direct light).

Advantages
<ul style="list-style-type: none"> ■ No leach of DEHP. ■ Automatic prime stop thanks to a hydrophobic filter contained in the downstream protector cap. ■ Security of good set positioning in the pump. ■ Security against free flow when the set is removed from the pump. ■ Set recognition by the pump. ■ Preparation and priming similar to a gravity set. ■ Visual control of the infusion. ■ Possible use by gravity. ■ No risk of allergy to latex.

nota bene

- Complies with ISO 1135/4 - 1998 standard.
- External studies have shown that the blood cells do not undergo any damages when delivered with the Volumat Agilia / Volumat MC Agilia infusion pumps.in association with this set (test report available on request).

VL TR12 NEW

M46442700

Vented set for transfusion, 200 μ filter, 1 K-Nect needle-free access

To infuse blood / fluid bags or bottles with Volumat Agilia / Volumat MC Agilia infusion pumps.

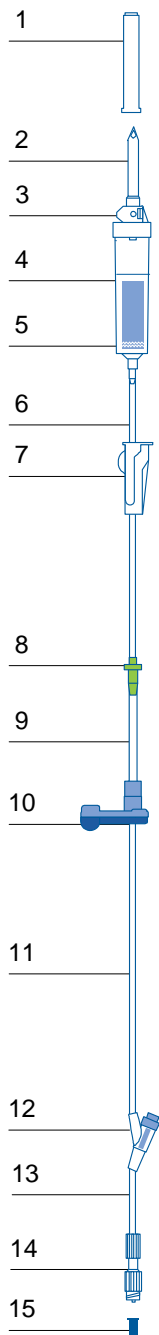

	Description
1.	Protector cap
2.	Vented spike
3.	Air inlet with antibacterial filter and cap
4.	Transparent drip chamber, length ~ 90 mm
5.	Blood filter 200 μ (surface > 10 cm ²)
6.	PVC tubing (DEHP-free): diameter 3 x 4.1 mm, length ~ 90 cm
7.	Roller clamp
8.	Green connector
9.	Calibrated silicone pumping segment
10.	Blue SafeClip: anti-free flow safety clamp
11.	PVC tubing (DEHP-free): diameter 3 x 4.1 mm, length ~ 145 cm
12.	K-Nect Needle-free access
13.	PVC tubing (DEHP-free): diameter 3 x 4.1 mm, length ~ 20 cm
14.	Rotating Male Luer Lock
15.	Stopflow cap

Approximate length: ~ 270 cm

Approximate priming volume: ~ 25 ml

Main materials: PVC, Silicone

Important: DEHP-free, latex-free

Packaging
<ul style="list-style-type: none"> ■ Peel-open pouch. ■ Ethylene oxide sterilization. ■ Expiry: 5 years after manufacturing. ■ Case quantity: 30 units (6x5). ■ Pallet of 1680 sets. ■ Storage conditions: +5 to +30°C, maximum humidity 70%.

Applications
<ul style="list-style-type: none"> ■ Transfusion of blood products available in bags.

Not to be used for
<ul style="list-style-type: none"> ■ Infusion of drugs / fluids requiring a filtration with a narrow diameter filter. ■ Infusion of drugs known to be incompatible with PVC (e.g. trinitrine, isosorbide dinitrate, sodium nitroprussiate...). ■ Light sensitive drugs (unless other precautions are taken to protect the drug against direct light). ■ Needle-free access should not be used to connect a gravity line (unless it is protected by a back check valve).

Advantages
<ul style="list-style-type: none"> ■ No leach of DEHP. ■ Automatic prime stop thanks to a hydrophobic filter contained in the downstream protector cap. ■ Security of good set positioning in the pump. ■ Security against free flow when the set is removed from the pump. ■ Set recognition by the pump. ■ Preparation and priming similar to a gravity set. ■ Visual control of the infusion. ■ Possible use by gravity. ■ No risk of allergy to latex.

nota bene

- Complies with ISO 1135/4 - 1998 standard.
- External studies have shown that the blood cells do not undergo any damages when delivered with the Volumat Agilia / Volumat MC Agilia infusion pumps.in association with this set (test report available on request).

VL TR22

M46443000

Set for transfusion and infusion, 200 µ filter, 2 K-Nect needle-free accesses

To infuse blood bags, fluid bags or bottles with Volumat Agilia / Volumat MC Agilia infusion pumps.

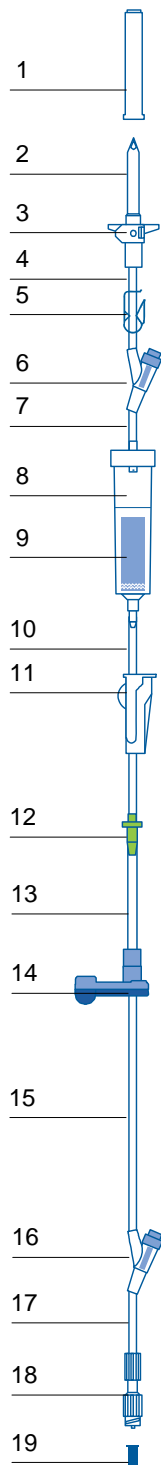

Description	
1.	Protector cap
2.	Vented spike
3.	Air inlet with antibacterial filter and cap
4.	PVC tubing (DEHP-free): diameter 3 x 4.1 mm, length ~ 10 cm
5.	Robson clamp
6.	K-Nect Needle-free access
7.	PVC tubing (DEHP-free): diameter 3 x 4.1 mm, length ~ 10 cm
8.	In-line transparent drip chamber
9.	Blood filter 200 µ (surface > 10 cm ²)
10.	PVC tubing (DEHP-free): diameter 3 x 4.1 mm, length ~ 70 cm
11.	Roller clamp
12.	Green connector
13.	Calibrated silicone pumping segment
14.	Blue SafeClip: anti-free flow safety clamp
15.	PVC tubing (DEHP-free): diameter 3 x 4.1 mm, length ~ 145 cm
16.	K-Nect Needle-free access
17.	PVC tubing (DEHP-free): diameter 3 x 4.1 mm, length ~ 20 cm
18.	Rotating Male Luer Lock
19.	Stopflow cap

Approximate length: ~ 270 cm

Approximate priming volume: ~ 25 ml

Main materials: PVC, Silicone

Important: DEHP-free, latex-free

Packaging	
■	Peel-open pouch.
■	Ethylene oxide sterilization.
■	Expiry: 5 years after manufacturing.
■	Case quantity: 30 units (6x5).
■	Pallet of 1680 sets.
■	Storage conditions: +5 to +30°C, maximum humidity 70%.

Applications	
■	Transfusion or infusion from bags or bottles.

Not to be used for	
■	Infusion of drugs / fluids requiring a filtration with a narrow diameter filter.
■	Infusion of drugs known to be incompatible with PVC (e.g. trinitrine, isosorbide dinitrate, sodium nitroprussiate...).
■	Light sensitive drugs (unless other precautions are taken to protect the drug against direct light).
■	Needle-free access should not be used to connect a gravity line (unless it is protected by a back check valve).

Advantages	
■	No leach of DEHP.
■	Automatic prime stop thanks to a hydrophobic filter contained in the downstream protector cap.
■	Allows connection of secondary lines for piggy-backing.
■	Allows intermittent injections of drugs.
■	Reduces risk of needle-stick injuries.
■	Security of good set positioning in the pump.
■	Security against free flow when the set is removed from the pump.
■	Set recognition by the pump.
■	Preparation and priming similar to a gravity set.
■	Visual control of the infusion.
■	Possible use by gravity.
■	No risk of allergy to latex.

nota bene

- Complies with ISO 1135/4 - 1998 standard.
- External studies have shown that the blood cells do not undergo any damages when delivered with the Volumat Agilia / Volumat MC Agilia infusion pumps in association with this set (test report available on request).

VL TR42 NEW

M46442900

Vented set for transfusion, 200 µ filter, 2 K-Nect needle-free accesses, 1 one-way check valve

To infuse blood / fluid bags or bottles with Volumat Agilia / Volumat MC Agilia infusion pumps.

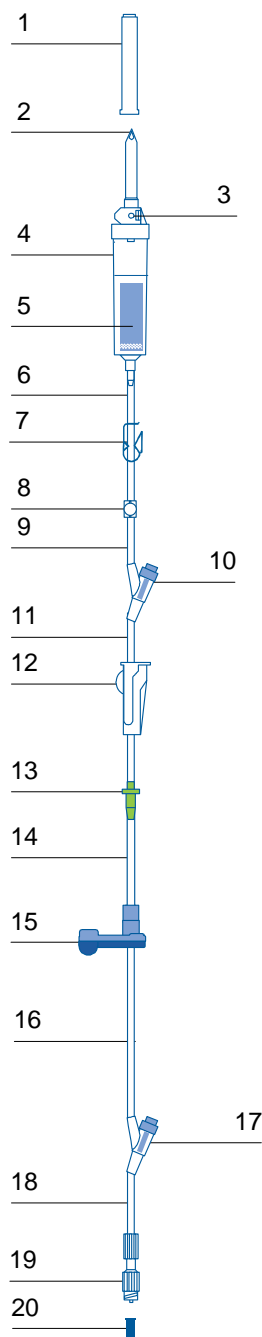

	Description
1.	Protector cap
2.	Vented spike
3.	Air inlet with antibacterial filter and cap
4.	Transparent drip chamber, length ~ 90 mm
5.	Blood filter 200 µ (surface > 10 cm ²)
6.	PVC tubing (DEHP-free): diameter 3 x 4.1 mm, length ~ 25 cm
7.	Robson clamp
8.	One-way check valve
9.	PVC tubing (DEHP-free): diameter 3 x 4.1 mm, length ~ 5 cm
10.	K-Nect Needle-free access
11.	PVC tubing (DEHP-free): diameter 3 x 4.1 mm, length ~ 60 cm
12.	Roller clamp
13.	Green connector
14.	Calibrated silicone pumping segment
15.	Blue SafeClip: anti-free flow safety clamp
16.	PVC tubing (DEHP-free): diameter 3 x 4.1 mm, length ~ 145 cm
17.	K-Nect Needle-free access
18.	PVC tubing (DEHP-free): diameter 3 x 4.1 mm, length ~ 20 cm
19.	Rotating Male Luer Lock
20.	Stopflow cap

Approximate length: ~ 275 cm

Approximate priming volume: ~ 25 ml

Main materials: PVC, Silicone

Important: DEHP-free, latex-free

Packaging
<ul style="list-style-type: none"> ■ Peel-open pouch. ■ Ethylene oxide sterilization. ■ Expiry: 5 years after manufacturing. ■ Case quantity: 30 units (6x5). ■ Pallet of 1680 sets. ■ Storage conditions: +5 to +30°C, maximum humidity 70%.

Applications
<ul style="list-style-type: none"> ■ Transfusion of blood products available in bags.

Not to be used for
<ul style="list-style-type: none"> ■ Infusion of drugs / fluids requiring a filtration with a narrow diameter filter. ■ Infusion of drugs known to be incompatible with PVC (e.g. trinitrine, isosorbide dinitrate, sodium nitroprussiate...). ■ Light sensitive drugs (unless other precautions are taken to protect the drug against direct light). ■ Needle-free access should not be used to connect a gravity line (unless it is protected by a back check valve).

Advantages
<ul style="list-style-type: none"> ■ No leach of DEHP. ■ Automatic prime stop thanks to a hydrophobic filter contained in the downstream protector cap. ■ Security of good set positioning in the pump. ■ Security against free flow when the set is removed from the pump. ■ Set recognition by the pump. ■ Preparation and priming similar to a gravity set. ■ Visual control of the infusion. ■ Possible use by gravity. ■ No risk of allergy to latex.

nota bene

- Complies with ISO 1135/4 - 1998 standard.
- External studies have shown that the blood cells do not undergo any damages when delivered with the Volumat Agilia / Volumat MC Agilia infusion pumps in association with this set (test report available on request).

Due to our policy of continuous product improvements as well as changes in standards, the features described in this documents may change. Please consult us for the current situation.

VL SP22

M46443100

Dual set for transfusion / infusion, 200 µ filter, K-Nect needle free access

To infuse fluid bags with Volumat MC Agilia infusion pump.

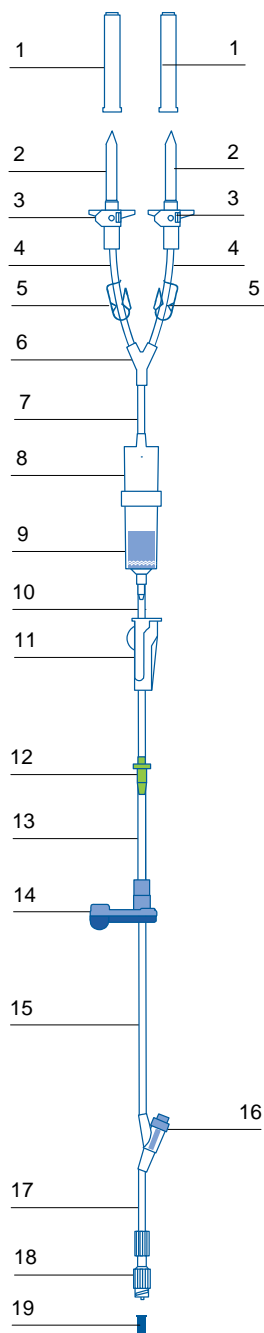

Description

1. Protector caps
2. Vented spikes
3. Air inlet with antibacterial filter and cap
4. PVC tubing (DEHP-free): diameter 3 x 4.1 mm, length = 15 cm
5. Robson clamp
6. Y connector
7. PVC tubing (DEHP-free): diameter 3 x 4.1 mm, length = 5 cm
8. Transparent in-line drip chamber, length ~ 90 mm
9. 200 µ filter (surface >10cm²)
10. PVC tubing (DEHP-free): diameter 3 x 4.1 mm, length ~ 70 cm
11. Roller clamp
12. Green connector
13. Calibrated silicone pumping segment
14. Blue SafeClip: anti-free flow safety clamp
15. PVC tubing (DEHP-free): diameter 3 x 4.1 mm, length ~ 145 cm
16. K-Nect Needle-free access
17. PVC tube diameter 3 x 4.1, length ~20 cm
18. Rotating Male Luer Lock
19. Stopflow cap

Approximate length: ~ 270 cm

Approximate priming volume: ~ 30 ml

Main materials: PVC, Silicone

Important: DEHP-free, latex-free

Packaging

- Peel-open pouch.
- Ethylene oxide sterilization.
- Expiry: 5 years after manufacturing.
- Case quantity: 30 units (6x5).
- Pallet of 1680 sets.
- Storage conditions: +5 to +30°C, maximum humidity 70%.

Applications

- Infusion of drugs / fluids available in bags or in collapsible bottles.
- Infusion of drugs / fluids having no particular filtration requirement.
- Infusion of drugs/fluids having no particular incompatibility.

Not to be used for

- Infusion of drugs known to be incompatible with PVC (e.g. trinitrine, isosorbide dinitrate, sodium nitroprussiate...).
- Light sensitive drugs (unless other precautions are taken to protect the drug against direct light).
- Needle-free access should not be used to connect a gravity line (unless it is protected by a back check valve).

Advantages

- No leach of DEHP.
- Automatic prime stop thanks to a hydrophobic filter contained in the downstream protector cap.
- Allows infusion of two bags connected simultaneously.
- Allows intermittent injections of drugs.
- Allows connection of other gravity line on downstream connection site.
- Security of good set positioning in the pump.
- Security against free flow when the set is removed from the pump.
- Set recognition by the pump.
- Preparation and priming similar to a gravity set.
- Visual control of the infusion.
- Possible use by gravity.
- No risk of allergy to latex.

VL SP62

M46443400

Set for infusion of drugs incompatible with PVC, 15 µ filter, K-Nect needle-free access

To infuse fluid bags or bottles with Volumat Agilia / Volumat MC Agilia infusion pumps.

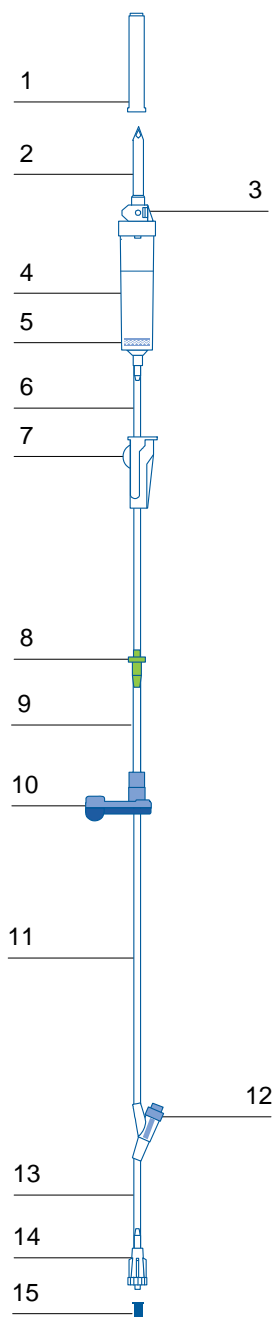

Description	
1.	Protector cap
2.	Vented spike
3.	Air inlet with antibacterial filter and cap
4.	Transparent drip chamber, length ~ 65 mm
5.	15 µ filter
6.	PUR tubing: diameter 3 x 4.1 mm, length ~ 90 cm
7.	Roller clamp
8.	Green connector
9.	Calibrated silicone pumping segment
10.	Blue SafeClip: anti-free flow safety clamp
11.	PP/PUR tubing: diameter 3 x 4.1 mm, length ~ 145 cm
12.	K-Nect Needle-free access
13.	PUR tubing: diameter 3 x 4.1 mm, length ~ 20 cm
14.	Luer Lock
15.	Stopflow cap

Approximate length: ~ 270 cm

Approximate priming volume: ~ 25 ml

Main materials: PUR, PP, Silicone

Important: PVC-free, DEHP-free, latex-free

Packaging	
■	Peel-open pouch.
■	Ethylene oxide sterilization.
■	Expiry: 5 years after manufacturing.
■	Case quantity: 30 units (6x5).
■	Pallet of 1680 sets.
■	Storage conditions: +5 to +30°C, maximum humidity 70%.

Applications	
■	Infusion of drugs non compatible with PVC.
■	Infusion of drugs / fluids having no particular filtration requirements.

Not to be used for	
■	Blood products.
■	Light sensitive drugs (unless other precautions are taken to protect the drug against direct light).
■	Needle-free access should not be used to connect a gravity line (unless it is protected by a back check valve).

Advantages	
■	No leach of DEHP.
■	Automatic prime stop thanks to a hydrophobic filter contained in the downstream protector cap.
■	No loss of activity with PVC-sensitive drugs.
■	Security of good set positioning in the pump.
■	Security against free flow when the set is removed from the pump.
■	Set recognition by the pump.
■	Preparation and priming similar to a gravity set.
■	Possible use with any bags or bottles.
■	Visual control of the infusion.
■	Possible use by gravity.
■	No risk of allergy to latex.

VL SP90 NEW

M46443500

PVC-free set for infusion of nitroglycerine, opaque, 15 µ filter

To infuse fluid bags or bottles with Volumat Agilia / Volumat MC Agilia infusion pumps.

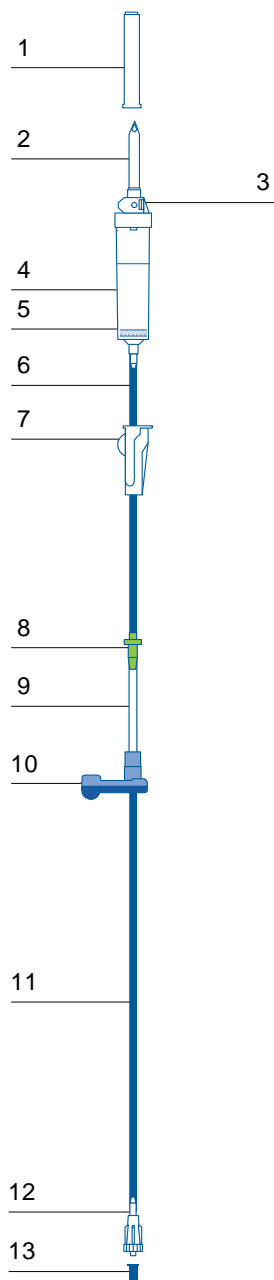

Description

1.	Protector cap
2.	Vented spike
3.	Air inlet with antibacterial filter and cap
4.	Transparent drip chamber
5.	15 µ filter
6.	Light protecting blue PUR tubing: diameter 3 x 4.1 mm, length ~ 90 cm
7.	Roller clamp
8.	Green connector
9.	Calibrated silicone pumping segment
10.	Blue SafeClip: anti-free flow safety clamp
11.	Light protecting blue PUR tubing: diameter 3 x 4.1 mm, length ~160 cm
12.	Male Luer Lock
13.	Stopflow cap

Approximate length: ~ 270 cm

Approximate priming volume: ~ 25 ml

Main materials: PUR, PP, Silicone

Important: PVC-free, DEHP-free, latex-free

Packaging

- Peel-open pouch.
- Ethylene oxide sterilization.
- Expiry: 5 years after manufacturing.
- Case quantity: 30 units (6x5).
- Pallet of 1680 sets.
- Storage conditions: +5 to +30°C, maximum humidity 70%.

Application

- Infusion of drugs having no particular filtration requirements.
- Infusion of drugs non compatible with PVC, or having interactions with plasticizer agents of PVC.

Not to be used for

- Blood products.

Advantages

- No leach of DEHP.
- Automatic prime stop thanks to a hydrophobic filter contained in the downstream protector cap.
- Protection of the staff against spilled liquids during the priming.
- Security of good set positioning in the pump.
- Security against free flow when the set is removed from the pump.
- Set recognition by the pump.
- Preparation and priming similar to a gravity set.
- Possible use with any bags or bottles.
- Visual control of the infusion.
- Possible use by gravity.
- No risk of allergy to latex.

VL SP92 NEW

M46443600

PVC-free set for infusion of nitroglycerine, opaque, 15 µ filter, 1 K-Nect needle free access

To infuse fluid bags or bottles with Volumat Agilia / Volumat MC Agilia infusion pumps.

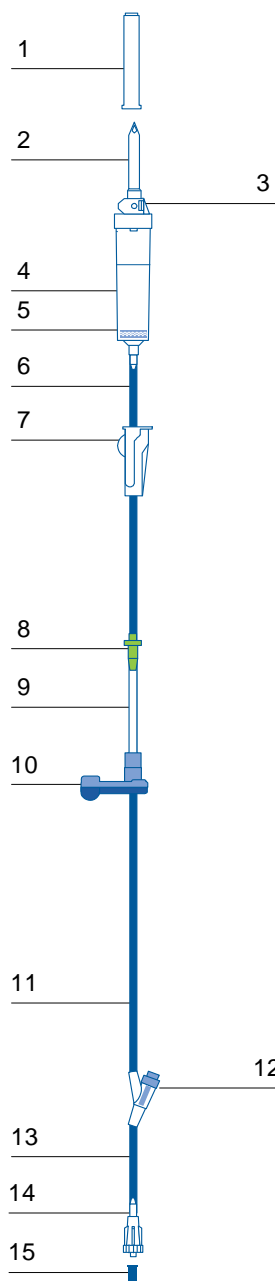

Description	
1.	Protector cap
2.	Vented spike
3.	Air inlet with antibacterial filter and cap
4.	Transparent drip chamber
5.	15 µ filter
6.	Light protecting blue PUR tubing: diameter 3 x 4.1 mm, length ~ 90 cm
7.	Roller clamp
8.	Green connector
9.	Calibrated silicone pumping segment
10.	Blue SafeClip: anti-free flow safety clamp
11.	Light protecting blue PUR tubing: diameter 3 x 4.1 mm, length ~145 cm
12.	K-Nect Needle-free access
13.	Light protecting blue PUR tubing: diameter 3 x 4.1 mm, length ~20 cm
14.	Male Luer Lock
15.	Stopflow cap

Approximate length: ~ 270 cm

Approximate priming volume: ~ 25 ml

Main materials: PUR, PP, Silicone

Important: PVC-free, DEHP-free, latex-free

Packaging	
■	Peel-open pouch.
■	Ethylene oxide sterilization.
■	Expiry: 5 years after manufacturing.
■	Case quantity: 30 units (6x5).
■	Pallet of 1680 sets.
■	Storage conditions: +5 to +30°C, maximum humidity 70%.

Application	
■	Infusion of drugs having no particular filtration requirements.
■	Infusion of drugs non compatible with PVC, or having interactions with plasticizer agents of PVC.

Not to be used for	
■	Blood products.
■	Needle-free access should not be used to connect a gravity line (unless it is protected by a back check valve).

Advantages	
■	No leach of DEHP.
■	Automatic prime stop thanks to a hydrophobic filter contained in the downstream protector cap.
■	Protection of the staff against spilled liquids during the priming.
■	Security of good set positioning in the pump.
■	Security against free flow when the set is removed from the pump.
■	Set recognition by the pump.
■	Preparation and priming similar to a gravity set.
■	Possible use with any bags or bottles.
■	Visual control of the infusion.
■	Possible use by gravity.
■	No risk of allergy to latex.

VL PN00

M46444300

Parenteral nutrition set, 1.2 µ air eliminating filter

To infuse fluid bags or bottles with Volumat Agilia / Volumat MC Agilia infusion pumps.

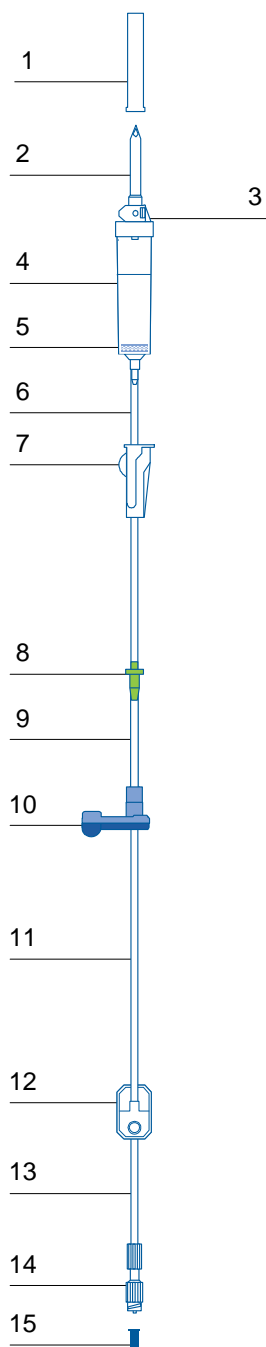

Description

1. Protector cap
2. Vented spike
3. Air inlet with antibacterial filter and cap
4. Transparent drip chamber, length ~ 65 mm
5. 15 µ filter
6. PVC tubing (DEHP-free): diameter 3 x 4.1 mm - length ~ 90 cm
7. Roller clamp
8. Green connector
9. Calibrated silicone pumping segment
10. Blue SafeClip: anti-free flow safety clamp
11. PVC tubing (DEHP-free): diameter 3 x 4.1 mm - length ~ 145 cm
12. 1.2 µ anti-bacterial and air-eliminating filter
13. PVC tubing (DEHP-free): diameter 3 x 4.1 mm - length ~ 20 cm
14. Rotating Male Luer Lock
15. Stopflow cap

Approximate length: ~ 270 cm

Approximate priming volume: ~ 25 ml

Main materials: PVC, Silicone

Important: DEHP-free, latex-free

Packaging

- Peel-open pouch.
- Ethylene oxide sterilization.
- Expiry: 5 years after manufacturing.
- Case quantity: 30 units (6x5).
- Pallet of 1680 sets.
- Storage conditions: +5 to +30°C, maximum humidity 70%.

Application

- Infusion of drugs requiring a 1.2 µ filter.
- Infusion of lipids and TPN solutions requiring a 1.2 µ filter.

Not to be used for

- Blood products.
- Light sensitive drugs (unless other precautions are taken to protect the drug against direct light).

Advantages

- No leach of DEHP.
- Automatic prime stop thanks to a hydrophobic filter contained in the downstream protector cap.
- No leaching of plasticizer agents (DOP, DEHP).
- Provide additional protection against bacterial contamination.
- Security of good set positioning in the pump.
- Security against free flow when the set is removed from the pump.
- Set recognition by the pump.
- Preparation and priming similar to a gravity set.
- Possible use with any bags or bottles.
- Visual control of the infusion.
- Possible use by gravity.
- No risk of allergy to latex.

VL PN02 NEW

M46444400

Parenteral nutrition set, 1.2 µ air eliminating filter, 1 K-Nect needle-free access

To infuse fluid bags or bottles with Volumat Agilia / Volumat MC Agilia infusion pumps.

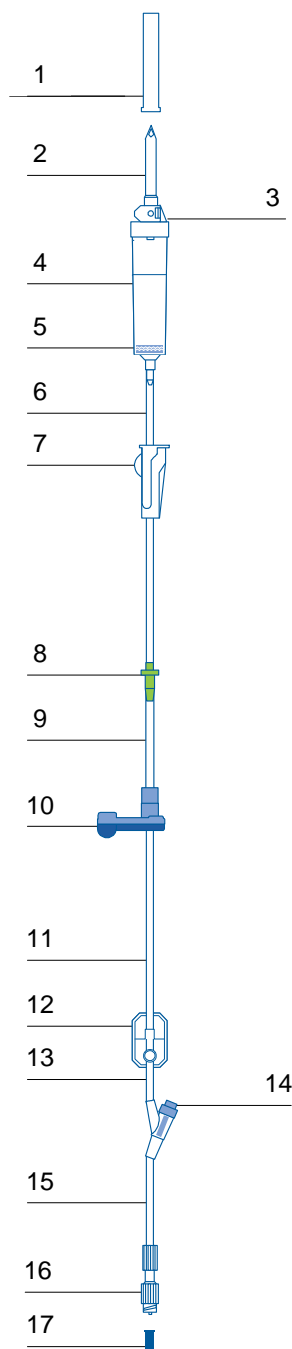

Description	
1.	Protector cap
2.	Vented spike
3.	Air inlet with antibacterial filter and cap
4.	Transparent drip chamber, length ~ 65 mm
5.	15 µ filter
6.	PVC tubing (DEHP-free): diameter 3 x 4.1 mm - length ~ 90 cm
7.	Roller clamp
8.	Green connector
9.	Calibrated silicone pumping segment
10.	Blue SafeClip: anti-free flow safety clamp
11.	PVC tubing (DEHP-free): diameter 3 x 4.1 mm - length ~ 145 cm
12.	1.2 µ anti-bacterial and air-eliminating filter
13.	PVC tubing (DEHP-free): diameter 3 x 4.1 mm - length ~ 5 cm
14.	K-Nect needle free access
15.	PVC tubing (DEHP-free): diameter 3 x 4.1 mm - length ~ 20 cm
16.	Rotating Male Luer Lock
17.	Stopflow cap

Approximate length: ~ 275 cm

Approximate priming volume: ~ 25 ml

Main materials: PVC, Silicone

Important: DEHP-free, latex-free

Packaging	
■	Peel-open pouch.
■	Ethylene oxide sterilization.
■	Expiry: 5 years after manufacturing.
■	Case quantity: 30 units (6x5).
■	Pallet of 1680 sets.
■	Storage conditions: +5 to +30°C, maximum humidity 70%.

Application	
■	Infusion of drugs requiring a 1.2 µ filter.
■	Infusion of lipids and TPN solutions requiring a 1.2 µ filter.

Not to be used for	
■	Blood products.
■	Light sensitive drugs (unless other precautions are taken to protect the drug against direct light).
■	Needle-free access should not be used to connect a gravity line (unless it is protected by a back check valve).

Advantages	
■	No leach of DEHP.
■	Automatic prime stop thanks to a hydrophobic filter contained in the downstream protector cap.
■	No leaching of plasticizer agents (DOP, DEHP).
■	Provide additional protection against bacterial contamination.
■	Security of good set positioning in the pump.
■	Security against free flow when the set is removed from the pump.
■	Set recognition by the pump.
■	Preparation and priming similar to a gravity set.
■	Possible use with any bags or bottles.
■	Visual control of the infusion.
■	Possible use by gravity.
■	No risk of allergy to latex.

VL PN20

M46443700

Parenteral nutrition set, 15 µ filter, upstream Luer lock connection

To infuse fluid bags with Volumat Agilia / Volumat MC Agilia infusion pumps.

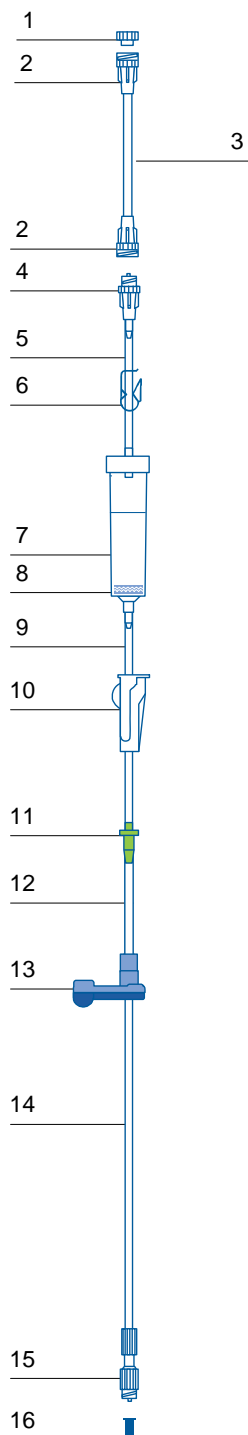

Description

1.	Protector cap
2.	Female Luer Lock
3.	PVC tubing (DEHP-free): diameter 3 x 4.1 mm, length ~ 15 cm
4.	Male Luer Lock
5.	PVC tubing (DEHP-free): diameter 3 x 4.1 mm, length ~ 5 cm
6.	Robson clamp
7.	Transparent drip chamber: length ~ 65 mm
8.	15 µ filter
9.	PVC tubing (DEHP-free): diameter 3 x 4.1 mm, length ~ 70 cm
10.	Roller clamp
11.	Green connector
12.	Calibrated silicone pumping segment
13.	Blue SafeClip: anti-free flow safety clamp
14.	PVC tubing (DEHP-free): diameter 3 x 4.1 mm, length ~ 165 cm
15.	Rotating Male Luer Lock
16.	Stopflow cap cap

Approximate length: ~ 270 cm

Approximate priming volume: ~ 26 ml

Main materials: PVC, Silicone

Important: DEHP-free, latex-free

Packaging

- Peel-open pouch.
- Ethylene oxide sterilization.
- Expiry: 5 years after manufacturing.
- Case quantity: 30 units (6x5).
- Pallet of 1680 sets.
- Storage conditions: +5 to +30°C, maximum humidity 70%.

Applications

- Infusion of drugs presented in bags equipped with a luer connector (male or female).
- Infusion of drugs / fluids having no particular filtration requirements.
- Infusion of drugs having no particular incompatibility.

Not to be used for

- Bottles and bags not equipped with a luer lock connection.
- Infusion of drugs known to be incompatible with PVC (e.g. trinitrine, isosorbide dinitrate, sodium nitroprussiate...).
- Blood cells.
- Light sensitive drugs (unless other precautions are taken to protect the drug against direct light).

Advantages

- No leach of DEHP.
- Automatic prime stop thanks to a hydrophobic filter contained in the downstream protector cap.
- Possible use with any bags equipped with luer connector.
- Possibility to connect the set to the bag in the preparation unit.
- Security of good set positioning in the pump.
- Security against free flow when the set is removed from the pump.
- Set recognition by the pump.
- Preparation and priming similar to a gravity set.
- Visual control of the infusion.
- Possible use by gravity.
- No risk of allergy to latex.

VL ON10 NEW

M46445500

Oncology set for infusion of drugs in closed system, 1 side line, 15 μ filter

To infuse fluid bags with female luer lock with Volumat Agilia / Volumat MC Agilia infusion pumps.

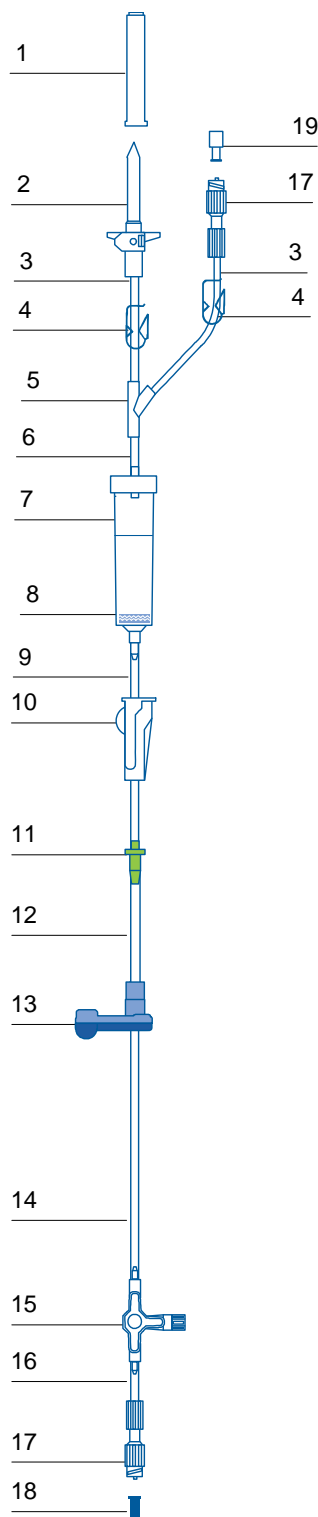

Description	
1.	Protective cap for Spike
2.	Vented spike
3.	PVC tubing (DEHP-free): $\varnothing 3 \times 4.1$ mm, length ~ 20 cm
4.	Robson clamp
5.	Y connector
6.	PVC tubing (DEHP-free): $\varnothing 3 \times 4.1$ mm, length ~ 10 cm
7.	In-line drip chamber
8.	15 μ filter
9.	PVC tubing (DEHP-free): diameter 3 x 4.1 mm, length ~ 50 cm
10.	Roller clamp
11.	Green connector
12.	Calibrated silicone pumping segment
13.	Blue SafeClip: anti-free flow safety clamp
14.	PVC tubing (DEHP-free): diameter 3 x 4.1 mm, length ~ 165 cm
15.	3-way stop-cock
16.	PVC-free tubing: diameter 3 x 4.1 mm, length ~ 30 cm
17.	Rotating Male Luer Lock
18.	Stopflow cap
19.	Femal luer lock tap

Approximate length: ~ 270-280 cm

Approximate priming volume: ~ 28 ml

Main materials: PVC, Silicone

Important: DEHP-free, latex-free, material suitable for infusion of Paclitaxel

Packaging	
■	Peel-open pouch.
■	Ethylene oxide sterilization.
■	Expiry: 5 years after manufacturing.
■	Case quantity: 30 units (6x5).
■	Pallet of 1680 sets.
■	Storage conditions: +5 to +30°C, maximum humidity 70%.

Applications	
■	Infusion of drugs / fluids available in bags with female luer lock (side line), infusion of drugs / fluids available in bags or bottles (main line).
■	Infusion of different drugs in the same set thanks to connections of side line in closed system.
■	Infusion of drugs / fluids having no particular filtration requirements.
■	Infusion of drugs / fluids having no particular incompatibility.

Not to be used for	
■	Spikeable bags or bottles in side line.
■	Light sensitive drugs (unless other precautions are taken to protect the drug against direct light).
■	Infusion of drugs known to be incompatible with PVC (e.g. trinitrine, isosorbide dinitrate, sodium nitroprussiate...)
■	Blood products.

Advantages	
■	Possibility to prepare one set connected to a bag in a closed system.
■	Automatic prime stop thanks to a hydrophobic filter contained in the downstream protector cap.
■	Closed system, limited exposure to spilled liquids.
■	Possibility to flush the line in order to limit the amount of drug left in the line.
■	Limited dead priming volume side line.
■	No leach of DEHP.
■	Security of good set positioning in the pump.
■	Security against free flow when the set is removed from the pump.
■	Set recognition by the pump.
■	Possible use with any bags or bottles in the primary line.
■	Visual control of the infusion.
■	Possible use by gravity.
■	No risk of allergy to latex.

VL ON20 NEW

M46445700

Oncology set for multi infusion of drugs in closed system, 2 side lines, 15µ filter

To infuse fluid bags or bottles with Volumat Agilia / Volumat MC Agilia infusion pumps.

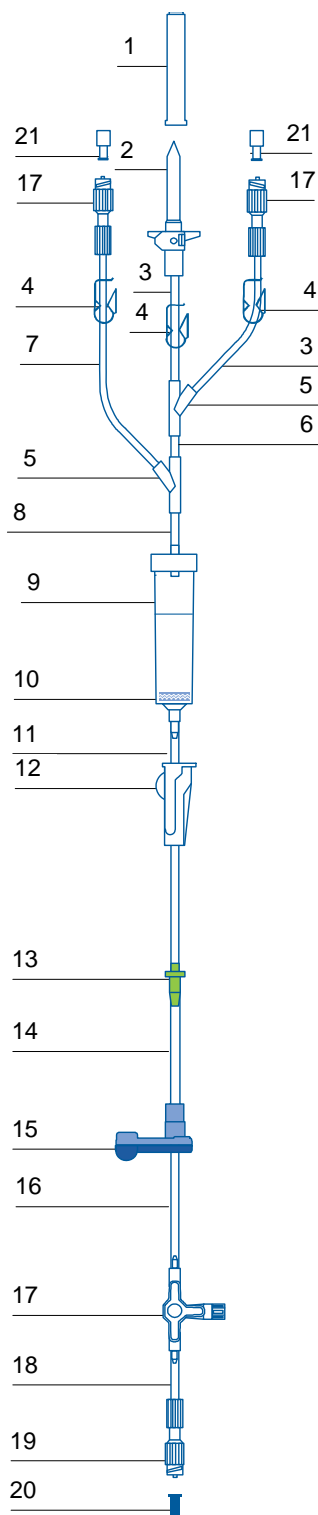

Description	
1.	Protective cap for Spike
2.	Vented spike
3.	PVC tubing (DEHP-free): Ø3 x 4.1 mm, length ~ 20 cm
4.	Robson clamp
5.	Y connector
6.	PVC tubing (DEHP-free): Ø3 x 4.1 mm, length ~ 5 cm
7.	PVC tubing (DEHP-free): Ø3 x 4.1 mm, length ~ 25 cm
8.	PVC tubing (DEHP-free): Ø3 x 4.1 mm, length ~ 10 cm
9.	In-line drip chamber
10.	15 µ filter
11.	PVC tubing (DEHP-free): diameter 3 x 4.1 mm, length ~ 50 cm
12.	Roller clamp
13.	Green connector
14.	Calibrated silicone pumping segment
15.	Blue SafeClip anti-free flow safety clamp
16.	PVC tubing (DEHP-free): diameter 3 x 4.1 mm, length ~ 165 cm
17.	3-way stop-cock
18.	PVC tubing (DEHP-free): diameter 3 x 4.1 mm, length ~ 30 cm
19.	Rotating Male Luer Lock
20.	Stopflow cap
21.	Femal luer lock tap

Approximate length: ~ 270-280 cm

Approximate priming volume: ~ 30 ml

Main materials: PVC, Silicone

Important: DEHP-free, latex-free, material suitable for infusion of Paclitaxel

Packaging	
■	Peel-open pouch.
■	Ethylene oxide sterilization.
■	Expiry: 5 years after manufacturing.
■	Case quantity: 30 units (6x5).
■	Pallet of 1680 sets.
■	Storage conditions: +5 to +30°C, maximum humidity 70%.

Applications	
■	Infusion of drugs / fluids available in bags with female luer lock (side lines), infusion of drugs / fluids available in bags or bottles (main line).
■	Infusion of different drugs in the same set thanks to connections of side lines in closed system.
■	Infusion of drugs / fluids having no particular filtration requirements.
■	Infusion of drugs / fluids having no particular incompatibility.

Not to be used for	
■	Spikeable bags or bottles in side line.
■	Light sensitive drugs (unless other precautions are taken to protect the drug against direct light).
■	Infusion of drugs known to be incompatible with PVC (e.g. trinitrine, isosorbide dinitrate, sodium nitroprussiate...)
■	Blood products.

Advantages	
■	Possibility to prepare one set connected to different bags in a closed system.
■	Automatic prime stop thanks to a hydrophobic filter contained in the downstream protector cap.
■	Closed system, limited exposure to spilled liquids.
■	Possibility to flush the line in order to limit the amount of drug left in the line.
■	Limited dead priming volume side line.
■	No leach of DEHP.
■	Security of good set positioning in the pump.
■	Security against free flow when the set is removed from the pump.
■	Set recognition by the pump.
■	Possible use with any bags or bottles in the primary line.
■	Visual control of the infusion.
■	Possible use by gravity.
■	No risk of allergy to latex.

Due to our policy of continuous product improvements as well as changes in standards, the features described in this documents may change. Please consult us for the current situation.

VL ON30 NEW

M46445900

Oncology set for multi infusion of drugs in closed system, 3 side lines, 15 μ filter

To infuse fluid bags or bottles with Volumat Agilia / Volumat MC Agilia infusion pumps.

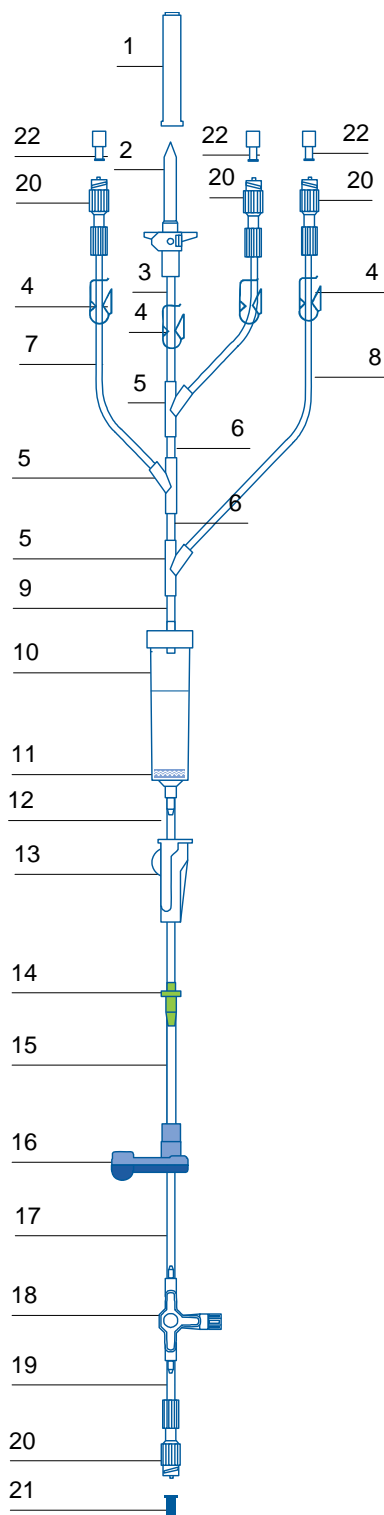

	Description
1.	Protective cap for Spike
2.	Vented spike
3.	PVC tubing (DEHP-free): Ø3 x 4.1 mm, length ~ 20 cm
4.	Robson clamp
5.	Y connector
6.	PVC tubing (DEHP-free): Ø3 x 4.1 mm, length ~ 5 cm
7.	PVC tubing (DEHP-free): Ø3 x 4.1 mm, length ~ 25 cm
8.	PVC tubing (DEHP-free): Ø3 x 4.1 mm, length ~ 30 cm
9.	PVC tubing (DEHP-free): Ø3 x 4.1 mm, length ~ 10 cm
10.	In-line drip chamber
11.	15 μ filter
12.	PVC tubing (DEHP-free): diameter 3 x 4.1 mm, length ~ 50 cm
13.	Roller clamp
14.	Green connector
15.	Calibrated silicone pumping segment
16.	Blue SafeClip: anti-free flow safety clamp
17.	PVC-free tubing: diameter 3 x 4.1 mm, length ~ 165 cm
18.	3-way stop-cock
19.	PVC tubing (DEHP-free): diameter 3 x 4.1 mm, length ~ 30 cm
20.	Rotating Male Luer Lock
21.	Stopflow cap
22.	Femal luer lock tap

Approximate length: ~ 270-280 cm

Approximate priming volume: ~ 33 ml

Main materials: PVC, Silicone

Important: DEHP-free, latex-free, material suitable for infusion of Paclitaxel

Packaging
<ul style="list-style-type: none"> ■ Peel-open pouch. ■ Ethylene oxide sterilization. ■ Expiry: 5 years after manufacturing. ■ Case quantity: 30 units (6x5). ■ Pallet of 1680 sets. ■ Storage conditions: +5 to +30°C, maximum humidity 70%.

Applications
<ul style="list-style-type: none"> ■ Infusion of drugs / fluids available in bags with female luer lock (side lines), infusion of drugs / fluids available in bags or bottles (main line). ■ Infusion of different drugs in the same set thanks to connections of side lines in closed system. ■ Infusion of drugs / fluids having no particular filtration requirements. ■ Infusion of drugs / fluids having no particular incompatibility

Not to be used for
<ul style="list-style-type: none"> ■ Spikeable bags or bottles in side line ■ Light sensitive drugs (unless other precautions are taken to protect the drug against direct light). ■ Infusion of drugs known to be incompatible with PVC (e.g. trinitrine, isosorbide dinitrate, sodium nitroprussiate...) ■ Blood products

Advantages
<ul style="list-style-type: none"> ■ Possibility to prepare one set connected to different bags in a closed system. ■ Automatic prime stop thanks to a hydrophobic filter contained in the downstream protector cap. ■ Closed system, limited exposure to spilled liquids ■ Possibility to flush the line in order to limit the amount of drug left in the line. ■ Limited dead priming volume side line. ■ No leach of DEHP. ■ Security of good set positioning in the pump. ■ Security against free flow when the set is removed from the pump. ■ Set recognition by the pump. ■ Possible use with any bags or bottles in the primary line. ■ Visual control of the infusion. ■ Possible use by gravity. ■ No risk of allergy to latex.

VL ON42

M46444000

Oncology set for multi infusion of drugs in closed system, 4 K-Nect needle-free accesses, 15 μ filter

To infuse fluid bags or bottles with Volumat Agilia / Volumat MC Agilia infusion pumps.

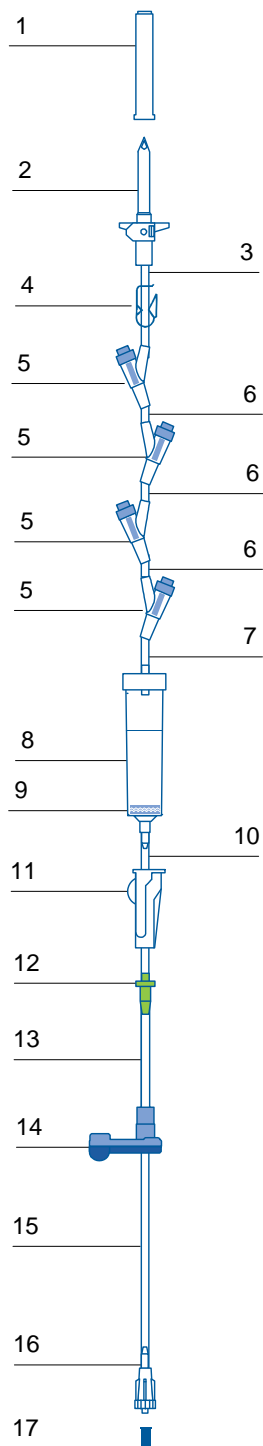

	Description
1.	Protector cap
2.	Vented spike
3.	PUR tubing: $\varnothing 3 \times 4.1$ mm, length ~ 20 cm
4.	Robson clamp
5.	K-Nect Needle-free access
6.	PUR tubing: $\varnothing 3 \times 4.1$ mm, length ~ 5 cm
7.	PUR tubing: $\varnothing 3 \times 4.1$ mm, length ~ 10 cm
8.	Transparent in-line drip chamber, length ~ 70 mm
9.	15 μ filter
10.	PUR tubing: diameter 3×4.1 mm, length ~ 70 cm
11.	Roller clamp
12.	Green connector
13.	Calibrated silicone pumping segment
14.	Blue SafeClip: anti-free flow safety clamp
15.	PP tubing: diameter 3×4.1 mm, length ~ 165 cm
16.	Male Luer Lock
17.	Stopflow cap

Approximate length: ~ 270 cm

Approximate priming volume: ~ 30 ml

Main materials: PUR, PP, Silicone

Important: PVC-free, DEHP-free, latex-free, material suitable for infusion of Paclitaxel

Packaging
<ul style="list-style-type: none"> ■ Peel-open pouch. ■ Ethylene oxide sterilization. ■ Expiry: 5 years after manufacturing. ■ Case quantity: 30 units (6x5). ■ Pallet of 1680 sets. ■ Storage conditions: +5 to +30°C, maximum humidity 70%.

Applications
<ul style="list-style-type: none"> ■ Infusion of drugs / fluids available in bags or in collapsible bottles. ■ Infusion of different drugs in the same set thanks to connections of secondary lines in closed system. ■ Infusion of drugs non compatible with PVC, or having interactions with plasticizer agents of PVC. ■ Infusion of drugs / fluids having no particular filtration requirements.

Not to be used for
<ul style="list-style-type: none"> ■ Light sensitive drugs (unless other precautions are taken to protect the drug against direct light). ■ Rigid bottles (unless a separate air-vent is used).

Advantages
<ul style="list-style-type: none"> ■ No leach of DEHP. ■ Automatic prime stop thanks to a hydrophobic filter contained in the downstream protector cap. ■ Possibility to prepare one set connected to different line in a closed system. ■ No risk of back flow to secondary lines. ■ No loss of activity with PVC-sensitive drugs. ■ No leaching of plasticizer agents (DOP, DEHP). ■ Security of good set positioning in the pump. ■ Security against free flow when the set is removed from the pump. ■ Set recognition by the pump. ■ Preparation and priming similar to a gravity set. ■ Possible use with any bags or bottles. ■ Visual control of the infusion. ■ Possible use by gravity. ■ No risk of allergy to latex.

VL ON70

M46444600

Oncology set for infusion, 0.2 µ filter

To infuse fluid bags or bottles with Volumat Agilia / Volumat MC Agilia infusion pumps.

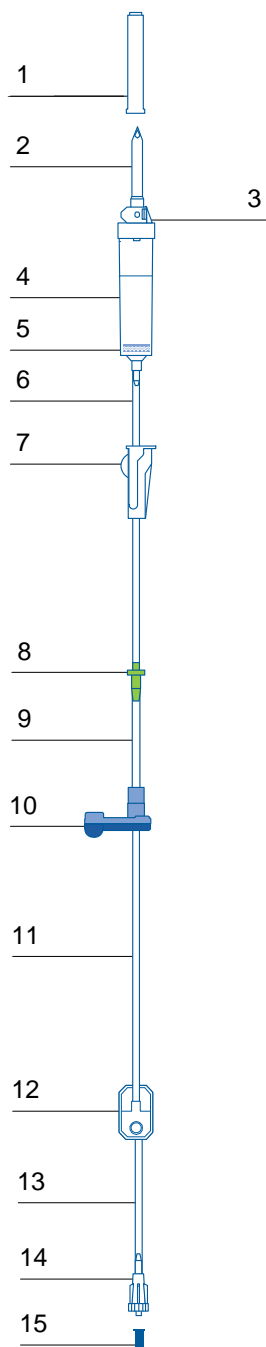

Description

1.	Protector cap
2.	Vented spike
3.	Air inlet with antibacterial filter and cap
4.	Transparent drip chamber, length ~ 65 mm
5.	15 µ filter
6.	PUR tubing: diameter 3 x 4.1 mm - length ~ 90 cm
7.	Roller clamp
8.	Green connector
9.	Calibrated silicone pumping segment
10.	Blue SafeClip: anti-free flow safety clamp
11.	PP tubing: diameter 3 x 4.1 mm - length ~ 145 cm
12.	0.2 µ anti-bacterial and air-eliminating filter (positively charged)
13.	PP tubing: diameter 3 x 4.1 mm - length ~ 20 cm
14.	Male Luer Lock
15.	Stopflow cap

Approximate length: ~ 270 cm

Approximate priming volume: ~ 25 ml

Main materials: PUR, PP, Silicone

Important: PVC-free, DEHP-free, latex-free, material is suitable for infusion of Paclitaxel

Packaging

- Peel-open pouch.
- Ethylene oxide sterilization.
- Expiry: 5 years after manufacturing.
- Case quantity: 30 units (6x5).
- Pallet of 1680 sets.
- Storage conditions: +5 to +30°C, maximum humidity 70%.

Application

- Infusion of drugs non compatible with PVC, or having interactions with plasticizer agents of PVC, and requiring a 0.2 µ filter.

Not to be used for

- Blood products.
- Total parenteral nutrition and other lipid containing solutions.
- Light sensitive drugs (unless other precautions are taken to protect the drug against direct light).
- Remicade.

Advantages

- No leach of DEHP.
- Automatic prime stop thanks to a hydrophobic filter contained in the downstream protector cap.
- No leaching of plasticizer agents (DOP, DEHP).
- No loss of activity with PVC-sensitive drugs.
- Provide additional protection against bacterial contamination.
- Security of good set positioning in the pump.
- Security against free flow when the set is removed from the pump.
- Set recognition by the pump.
- Preparation and priming similar to a gravity set.
- Possible use with any bags or bottles.
- Visual control of the infusion.
- Possible use by gravity.
- No risk of allergy to latex.

VL ON72 NEW

M46444100

Oncology set for infusion, 0.2 µ filter, 1 K-Nect needle free access

To infuse fluid bags or bottles with Volumat Agilia / Volumat MC Agilia infusion pumps.

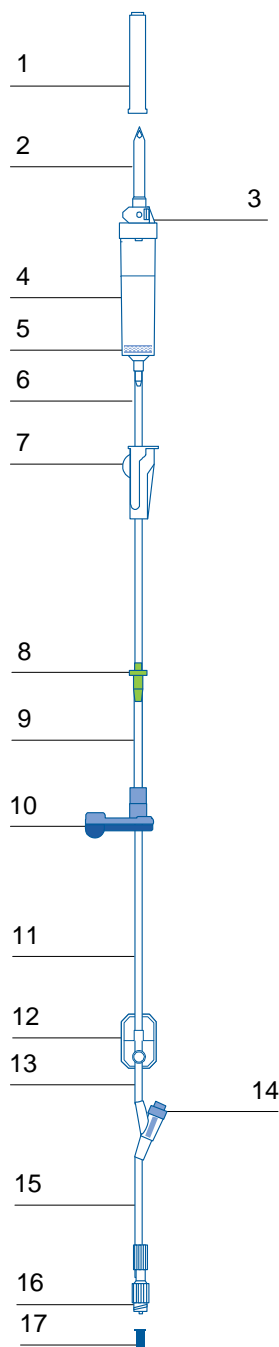

Description	
1.	Protector cap
2.	Vented spike
3.	Air inlet with antibacterial filter and cap
4.	Transparent drip chamber, length ~ 65 mm
5.	15 µ filter
6.	PUR tubing: diameter 3 x 4.1 mm - length ~ 90 cm
7.	Roller clamp
8.	Green connector
9.	Calibrated silicone pumping segment
10.	Blue SafeClip: anti-free flow safety clamp
11.	PP tubing: diameter 3 x 4.1 mm - length ~ 145 cm
12.	0.2 µ anti-bacterial and air-eliminating filter (positively charged)
13.	PUR tubing: diameter 3 x 4.1 mm - length ~ 5 cm
14.	K-Nect needle free access
15.	PUR tubing: diameter 3 x 4.1 mm - length ~ 20 cm
16.	Male Luer Lock
17.	Stopflow cap

Approximate length: ~ 275 cm

Approximate priming volume: ~ 25 ml

Main materials: PUR, PP, Silicone

Important: PVC-free, DEHP-free, latex-free, material is suitable for infusion of Paclitaxel

Packaging	
■	Peel-open pouch.
■	Ethylene oxide sterilization.
■	Expiry: 5 years after manufacturing.
■	Case quantity: 30 units (6x5).
■	Pallet of 1680 sets.
■	Storage conditions: +5 to +30°C, maximum humidity 70%.

Application	
■	Infusion of drugs non compatible with PVC, or having interactions with plasticizer agents of PVC, and requiring a 0.2 µ filter.

Not to be used for	
■	Blood products.
■	Total parenteral nutrition and other lipid containing solutions.
■	Light sensitive drugs (unless other precautions are taken to protect the drug against direct light).
■	Remicade.
■	Needle-free access should not be used to connect a gravity line (unless it is protected by a back check valve).

Advantages	
■	No leach of DEHP.
■	Automatic prime stop thanks to a hydrophobic filter contained in the downstream protector cap.
■	No leaching of plasticizer agents (DOP, DEHP).
■	No loss of activity with PVC-sensitive drugs.
■	Provide additional protection against bacterial contamination.
■	Security of good set positioning in the pump.
■	Security against free flow when the set is removed from the pump.
■	Set recognition by the pump.
■	Preparation and priming similar to a gravity set.
■	Possible use with any bags or bottles.
■	Visual control of the infusion.
■	Possible use by gravity.
■	No risk of allergy to latex.

VL ON90

M46444900

PVC-free set for epidural infusion, opaque, 15 µ filter

To infuse fluid bags or bottles with Volumat Agilia / Volumat MC Agilia infusion pumps.

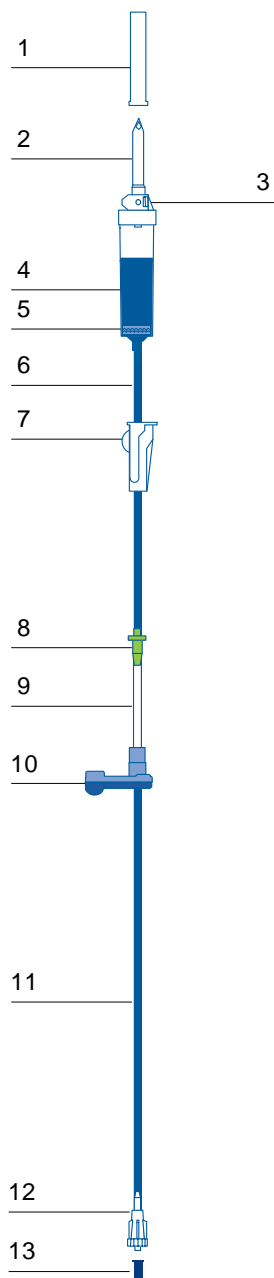

Description

1.	Protector cap
2.	Vented spike
3.	Air inlet with antibacterial filter and cap
4.	Light protecting drip chamber
5.	15 µ filter
6.	Light protecting PUR tubing (yellow): diameter 3 x 4.1 mm, length - 90 cm
7.	Roller clamp
8.	Green connector
9.	Calibrated silicone pumping segment
10.	Blue SafeClip: anti-free flow safety clamp
11.	Light protecting PUR tubing (yellow): diameter 3 x 4.1 mm, length -160 cm
12.	Male Luer Lock
13.	Stopflow cap

Approximate length: - 270 cm

Approximate priming volume: ~ 25 ml

Main materials: PUR, PP, Silicone

Important: PVC-free, DEHP-free, latex-free

Packaging

- Peel-open pouch.
- Ethylene oxide sterilization.
- Expiry: 5 years after manufacturing.
- Case quantity: 30 units (6x5).
- Pallet of 1680 sets.
- Storage conditions: +5 to +30°C, maximum humidity 70%.

Application

- Infusion of any drugs / fluids including light-sensitive drugs (including UV-sensitive drugs).
- Infusion of drugs having no particular filtration requirements.
- Infusion of drugs non compatible with PVC, or having interactions with plasticizer agents of PVC.

Not to be used for

- Blood products.

Advantages

- No leach of DEHP.
- Automatic prime stop thanks to a hydrophobic filter contained in the downstream protector cap.
- Protection of the drug against UV and visible light.
- Automatic prime stop thanks to a hydrophobic filter contained in the downstream protector cap.
- Protection of the staff against spilled liquids during the priming.
- Security of good set positioning in the pump.
- Security against free flow when the set is removed from the pump.
- Set recognition by the pump.
- Preparation and priming similar to a gravity set.
- Possible use with any bags or bottles.
- Visual control of the infusion.
- Possible use by gravity.
- No risk of allergy to latex.

VL PA02

M46442200

Infusion set for infusion, 15 µ filter, K-Nect needle-free access, microbore tube

To infuse fluid bags or bottles with Volumat Agilia / Volumat MC Agilia infusion pumps.

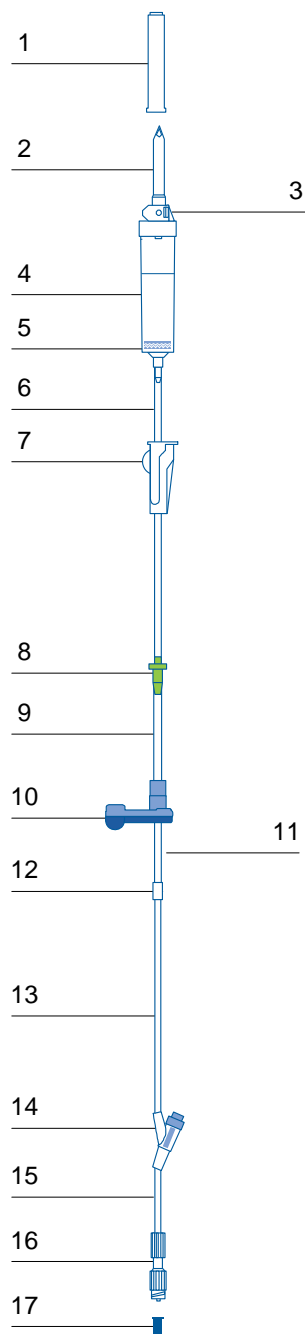

Description	
1.	Protector cap
2.	Vented spike
3.	Air inlet with antibacterial filter and cap
4.	Transparent drip chamber, length ~ 65 mm – 60 dr
5.	15 µ filter
6.	PVC tubing (DEHP-free): int. diameter 3 mm, length ~ 50 cm
7.	Roller clamp
8.	Green connector
9.	Calibrated silicone pumping segment
10.	Blue SafeClip: anti-free flow safety clamp
11.	PVC tubing (DEHP-free): int. diameter 3 mm, length ~ 10 cm
12.	Tube adaptor
13.	PVC tubing (DEHP-free): int. diameter 2 mm, length ~ 70 cm
14.	K-Nect needle-free access
15.	PVC tubing (DEHP-free): int. diameter 2 mm, length ~ 20 cm
16.	Rotating Male Luer Lock
17.	Stopflow cap

Approximate length: ~ 160 cm

Approximate priming volume: ~ 15 ml

Main Materials: PVC, Silicone

Important: DEHP-free, latex-free

Packaging	
■	Peel-open pouch.
■	Ethylene oxide sterilization.
■	Expiry: 5 years after manufacturing.
■	Case quantity: 30 units (6x5).
■	Pallet of 1680 sets.
■	Storage conditions: +5 to +30°C, maximum humidity 70%.

Applications	
■	Infusion of drugs / fluids having no particular filtration requirements.
■	Infusion of drugs / fluids having no particular incompatibility.

Not to be used for	
■	Infusion of drugs known to be incompatible with PVC (e.g. trinitrine, isosorbide dinitrate, sodium nitroprussiate...).
■	Blood products.
■	Light sensitive drugs (unless other precautions are taken to protect the drug against direct light).
■	Needle-free access should not be used to connect a gravity line (unless it is protected by a back check valve).

Advantages	
■	No leach of DEHP.
■	Automatic prime stop thanks to a hydrophobic filter contained in the downstream protector cap.
■	Allows intermittent injections of drugs.
■	Reduces risk of needle-stick injuries.
■	Easiness and hygiene of the gesture.
■	Security of good set positioning in the pump.
■	Security against free flow when the set is removed from the pump.
■	Set recognition by the pump.
■	Preparation and priming similar to a gravity set.
■	Possible use with any bags or bottles.
■	Visual control of the infusion.
■	Possible use by gravity.
■	No risk of allergy to latex.
■	Lower priming volume.
■	Faster response to downstream occlusions.

VL PA92

M46445200

Infusion set with 150 ml graduated burette, 20 drop/ml, 2 K-Nect needle-free accesses, 15 µ filter

To infuse fluid bags or bottles with Volumat MC Agilia infusion pump.

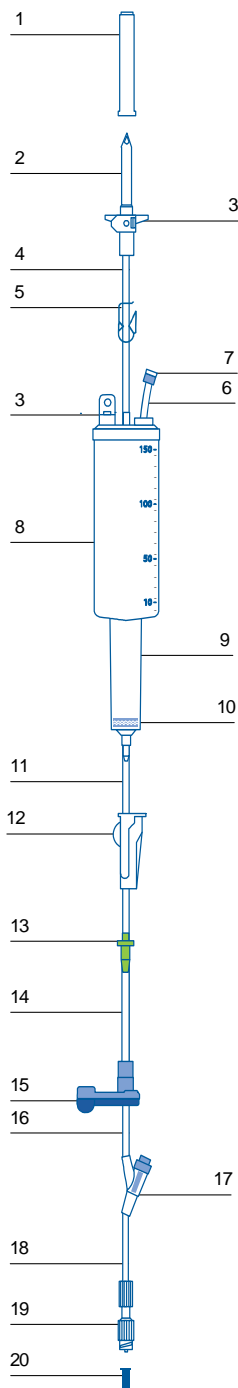

	Description
1.	Protector cap
2.	Vented spike
3.	Air inlet with antibacterial filter and cap
4.	PVC tubing (DEHP-free): diameter 3 x 4.1 mm, length ~ 20 cm
5.	Robson clamp
6.	PVC tubing (DEHP-free): diameter 3 x 4.1 mm, length ~ 3 cm
7.	K-Nect needle-free access
8.	150 ml Graduated burette
9.	Transparent drip chamber, 20 drop/ml
10.	15µ filter
11.	PVC tubing (DEHP-free): diameter 3 x 4.1 mm, length ~ 70 cm
12.	Roller clamp
13.	Green connector
14.	Calibrated silicone pumping segment
15.	Blue SafeClip: anti-free flow safety clamp
16.	PVC tubing (DEHP-free): diameter 3 x 4.1 mm, length ~ 145 cm
17.	K-Nect needle-free access
18.	PVC tubing (DEHP-free): diameter 3 x 4.1 mm, length ~ 20 cm
19.	Rotating Male luer lock
20.	Stopflow cap

Approximate length: ~ 300 cm

Approximate priming volume: ~ 25 ml (not including the burette's volume)

Tubing material: PVC, Silicone

Important: DEHP-free, latex-free

Packaging
<ul style="list-style-type: none"> ■ Peel-open pouch. ■ Ethylene oxide sterilization. ■ Expiry: 5 years after manufacturing. ■ Case quantity: 10 units. ■ Pallet of 360 sets. ■ Storage conditions: +5 to +30°C, maximum humidity 70%.

Applications
<ul style="list-style-type: none"> ■ Infusion of a precise volume out of a bag or bottle. ■ Mixing and adding of drugs into the burette. ■ Step by step infusion. ■ Infusion of drugs / fluids having no particular filtration requirements. ■ Infusion of drugs / fluids having no particular incompatibility.

Not to be used for
<ul style="list-style-type: none"> ■ Infusion of drugs known to be incompatible with PVC (e.g. trinitrine, isosorbide dinitrate, sodium nitroprusiate...). ■ Blood products. ■ Light sensitive drugs (unless other precautions are taken to protect the drug against direct light). ■ Needle-free access should not be used to connect a gravity line (unless it is protected by a back check valve).

Advantages
<ul style="list-style-type: none"> ■ No leach of DEHP. ■ Automatic prime stop thanks to a hydrophobic filter contained in the downstream protector cap. ■ Allows the infusion of a precisely known volume. ■ Allows intermittent injections of drugs into the burette or into the set. ■ Allows the mixing of different fluids / drugs in the burette. ■ No risk of drainage of the set. ■ Security of good set positioning in the pump. ■ Security against free flow when the set is removed from the pump. ■ Set recognition by the pump. ■ Possible use with any bags or bottles. ■ Visual control of the infusion. ■ Possible use by gravity. ■ No risk of allergy to latex.

Purge of the set used with a bag

- 1 Introduce the spike right down into the bag (roller clamp open – air inlet closed).
- 2 Press the bag in order to remove the air, and fill the drip chamber up to 1/2 to 2/3 of its capacity.
- 3 Hang the bag upside down, and let the liquid flow into the set.

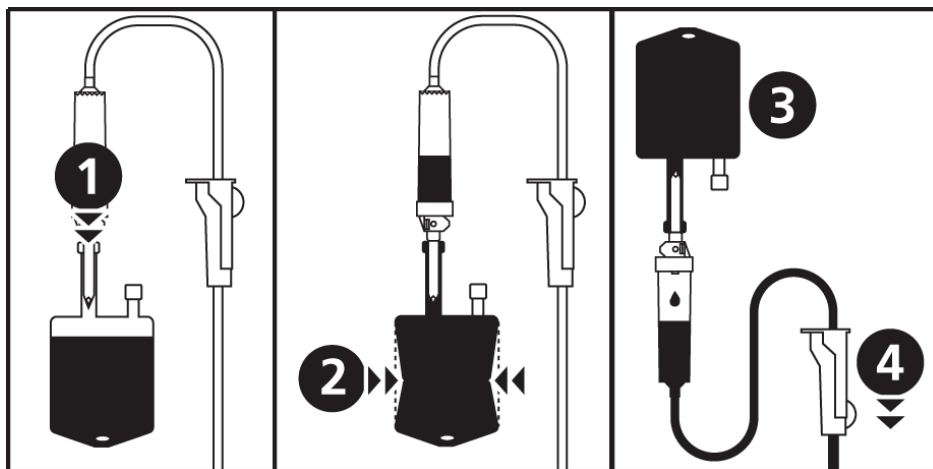

- 4 Once the set is completely primed, close the roller clamp and check absence of air bubbles.

Purge of the set used with a bottle

- 1 Introduce the spike right down into the bottle (roller clamp open – air inlet closed).
- 2 Close the roller clamp.
- 3 Hang the bottle upside down, then press the drip chamber in order to fill it to ~ 1/2 of its capacity.
- 4 Open the roller clamp.
- 5 Open the air inlet, and let the liquid flow into the set.

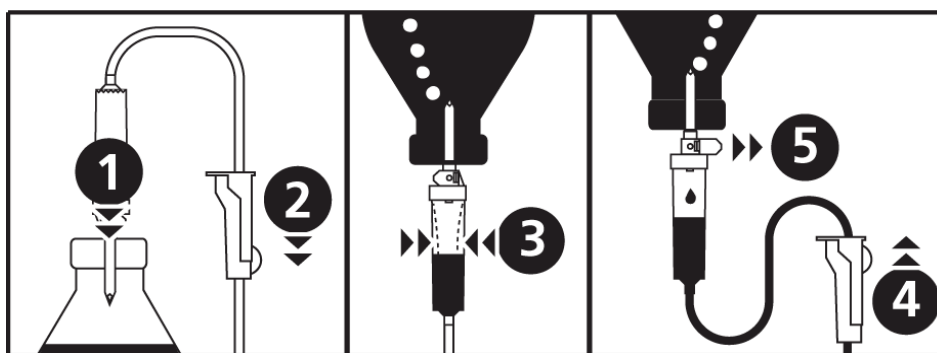

- 6 Once the set is completely primed, close the roller clamp and check absence of air bubbles.

Installation of the infusion set

- 1 Open the pump door by lifting the door lever.

Note: The pump automatically switches on when connected to mains. If not, press the <ON> key . An auto-test checks the functionality of the pump. Make sure that all LEDs and buzzers are activated.

- 2 Once the auto-test is OK, an alarm screen appears to indicate that you can start installing the tubing set.

Note: The flashing red leds indicate that it is an alarm. If no action is taken within 2 minutes, an audible signal will sound. Press the <SILENCE ALARM> key.

1. Align the tubing set horizontally along the tube guides so that the green connector is positioned to the right (green) and the blue clamp is positioned in front of the clamp guide (blue).
2. Insert the green connector into the green slot.
3. Position the blue SafeClip in its blue slot and then push the clamp to locate the spherical hinge into place.
4. Ensure that the tube is in the left tube guide, then push the door lever to close the pump door.

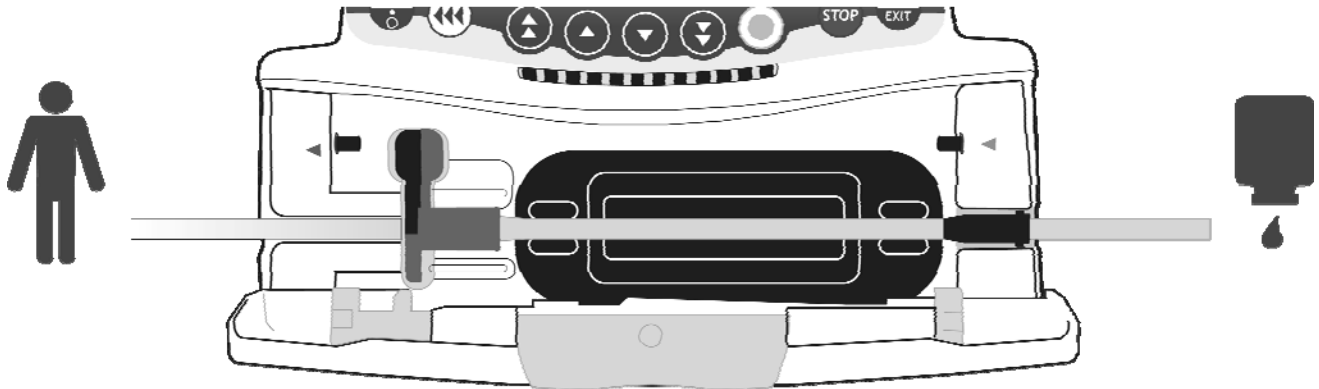

- 3 Occlusivity Check System automatically clamps the line, activates real pumping and checks pressure increase. The OCS-test checks the right set positioning and pump occlusivity, thus securing the pump against the risk of free-flow.

- 4 Place the container away from the pump.

The container should be placed 20 to 80 cm above the pump (h).

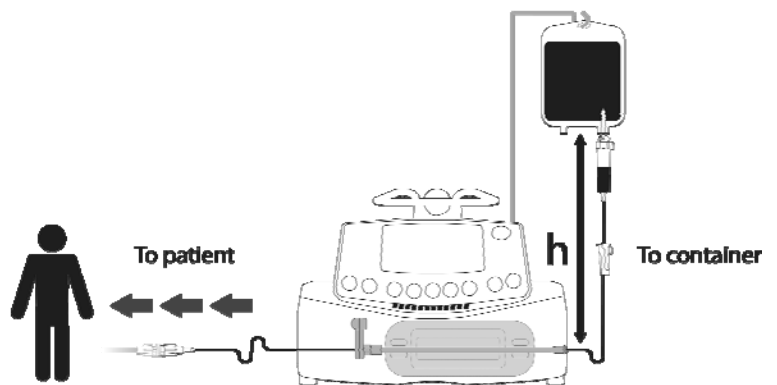

Desinstallation of the infusion set:

- 5 Remove the set by pulling on the safety clamp and on the administration set.



Release of the SafeClip:

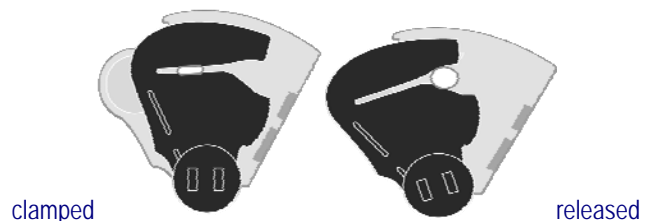



**Fresenius
Kabi**

EC DECLARATION OF CONFORMITY
EG-KONFORMITÄTSERKLÄRUNG

(annex II of Directive 93/42/EEC;
according to EC-certificate No. G1 07 06 47402 022 issued by notified body
TÜV Product Service GmbH 0123)

(gemäß Anhang II der Richtlinie 93/42/EWG;
entsprechend EG-Zertifikat No. G1 07 06 47402 022 ausgestellt durch die benannte Stelle
TÜV Product Service GmbH 0123)

Überleitgeräte / Giving Sets
für / for
Volumat Agilia / Volumat MC Agilia
(Product group or name / Produktgruppe oder Produktname)

see attached list/ siehe beigelegte Liste
(Article Number/ Artikelnummer)

Class/ Klasse IIa

We/ Wir

Fresenius Kabi AG
61346 Bad Homburg
Germany

Manufacturer of the above products, hereby confirm that they are manufactured according to /
Hersteller der oben genannten Produkte, erklären hiermit, daß diese gemäß der

Directive 93/42/EEC
Richtlinie 93/42/EWG

and are tested for conformity. The essential requirements are fulfilled and the products are authorised
to be labelled with the CE-mark according the directive 93/42/EEC.

hergestellt und auf Konformität bewertet wurden. Die grundlegenden Anforderungen sind erfüllt und
die Produkte sind somit berechtigt, die CE-Kennung gemäß der Richtlinie 93/42/EWG zu tragen.

Bad Hersfeld, 24. February 2009
place and date of issue

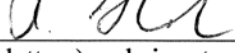
Dr. R. Hopf 
name (printed letters) and signature of authorized person

Gültig maximal drei Jahre ab Ausstellungsdatum bei unverändertem Produkt.
Valid three years at maximum starting with the origin date of the document for unchanged products.



Product Service

EC – CERTIFICATE

Full Quality Assurance System

(Annex II, section 3 of the Directive 93/42/EEC on Medical Devices)

No. G1 07 06 47402 022

Manufacturer:

Fresenius Kabi AG

Else-Kröner-Straße 1
61346 Bad Homburg
GERMANY

Product Category(ies):

ACTIVE MEDICAL DEVICES (class IIa / IIb)
Infusion and Enteral Feeding Pumps,
Devices for Patient Data Management,
Devices for Bioimpedance Measurement,
Drainage Containers,
Devices for Autotransfusion, Apheresis and
Cellseparation;
Accessories for Blood Donation Systems;
NON ACTIVE MEDICAL DEVICES (class IIa / IIb / III)
Enteral and Parenteral Feeding Products;
Infusion-, Transfusion- and Transfer Sets incl.
Accessories, Drainage Products, Irrigation Fluids,
Medical Containers, Disinfectants; Filter;
Catheters (class IIa / IIb / III) and
Portsystems (class III); Blood Donation Systems
and Accessories; Disposables for Autotransfusion,
Apheresis and Cellseparation;
Catheter Systems and Accessories

The Certification Body of TÜV SÜD Product Service GmbH declares that the aforementioned manufacturer has implemented a quality assurance system for design, manufacture and final inspection of the respective products / product categories according to Annex II section 3 of the Directive 93/42/EEC on Medical Devices. This quality assurance system conforms to the provisions of this Directive and is subject to periodical surveillance. For marketing of class III products an additional Annex II.4 certificate is mandatory. See also notes overleaf.

Report No.: 71313755

Valid until: 2012-06-07

Reiner Krumme



Date: 2007-06-20

TÜV SÜD PRODUCT SERVICE GMBH is Notified Body according to Council Directive 93/42/EEC concerning medical devices with identification no. 0123.

Page 1 of 3

TÜV SÜD Product Service GmbH · Zertifizierstelle · Ridlerstrasse 65 · 80339 München · Germany



Etablissement Français du Sang- Rhône Alpes- Contrôle Qualité

Résumé de l'étude

Objectif de l'étude :

Cette étude a pour objet d'évaluer si les Pompes Volumat de la société FRESSENIUS KABI présentent un effet délétère sur les Concentrés de Globules Rouges humains. (CGR).

Matériels et méthodes :

Cette étude porte sur la mesure de l'hémolyse de CGR perfusés avec les pompes VOLUMAT AGILIA avec sa tubulure spécifique.

Le protocole utilisé comporte deux phases :

1. Dans un premier temps, l'hémolyse est recherchée après un seul passage.

Les paramètres variables sont :

- l'âge des CGR : 21 et 42 jours
- le débit de la pompe : 200 ou 1200 ml
- le type de pompe utilisé : la pompe n°19800235 avec membrane classique et la pompe PSST 2-0110 avec une membrane semi-rigide (également appelée chenille).

2. Dans un second temps, des essais de passages successifs (10 fois) sont réalisés pour des CGR périmés (42 à 43 jours) et à 1200 ml/h. Ceci sur chacune des deux types de pompe.

Les paramètres mesurés sont l'hémolyse et la concentration en potassium extracellulaire.

Résultats :

Avec un taux d'hémolyse généré après un seul passage de 0,1 % et une très faible libération de potassium, on peut établir qu'un CGR, quel que soit son âge de conservation (dans la limite des 42 jours réglementaire) ne subit pas d'effet délétère significatif par passage dans les pompes VOLUMAT AGILIA évaluées.

Ces résultats sont confirmés par les essais réalisés en passages successifs 10 fois.

Conclusion :

Les pompes VOLUMAT AGILIA, utilisées dans les conditions normales d'emploi, ne génèrent pas d'effet délétère significatif sur la qualité des Concentrés de Globules Rouges Humains destinés à la transfusion.

Summary of the Study

Aim of the study:

The aim of this study is to evaluate a potential deleterious effect of the FRESSENIUS KABI VOLUMAT AGILIA peristaltic pump for intravenous perfusion of human Red Blood Cell concentrates (RBC).

Material and method:

The deleterious measured effect is the RBC's haemolysis when infused with VOLUMAT AGILIA pump and its associated tubing sets.

The protocol comprised two main steps:

1. First step : measurement of haemolysis and K^+ after one single pumping with the following variable parameters :
 - Age of the RBC's : 21 and 42 days
 - Flow rate : 200 ml/h and 1200 ml/h
 - Kind of pump : pump n°19800235 with standard membrane, and pump PSST 2-0110 with semi-rigid membrane (also called caterpillar).
2. Second step : multiple and successive pumping (10 times) is performed using a single outdated RBC (42 to 43 days) at 1200 ml/h. This trial was conducted on the two pumps.

The measured parameters are the haemolysis and the Extra-cellular potassium concentration.

Results :

With a rate of haemolysis after one single pumping always below 0.1% and a very low release of potassium, RBCs do not undergo any significant deleterious effect by the pumping of the VOLUMAT AGILIA. The age of the RBCs (within a legal limit of 42 days), and the flow rate have not significant effect.

These results are confirmed by trials performed 10 times successively.

Conclusion :

The Volumat AGILIA Pump from Fresenius Kabi, used under normal supplier defined conditions do not alter the quality of the Human Red Blood Cell concentrates for transfusion.

Stéphane BEGUÉ
Responsable contrôle Qualité EFS RA
Le 30/08/2007



This brochure may contain inaccuracies or typographical errors. Modifications may thus be made and will be included in later editions.

As standards and equipment change from time to time, the features shown and described in this document must be confirmed by our departments.

This brochure may not be reproduced in whole or in part without the written consent of Fresenius Kabi.

Volumat and Agilia are registered trademarks of Fresenius Kabi in selected countries.



**FRESENIUS
KABI**

caring for life

www.fresenius-kabi.com

Manufacturer

Fresenius Vial S.A.S

Le Grand Chemin

38590 Brézins

France

Tel: +33 (0)4 76 67 10 10

Fax: +33 (0)4 76 67 11 34

A Company of Fresenius Kabi